

The Ladies Quarters

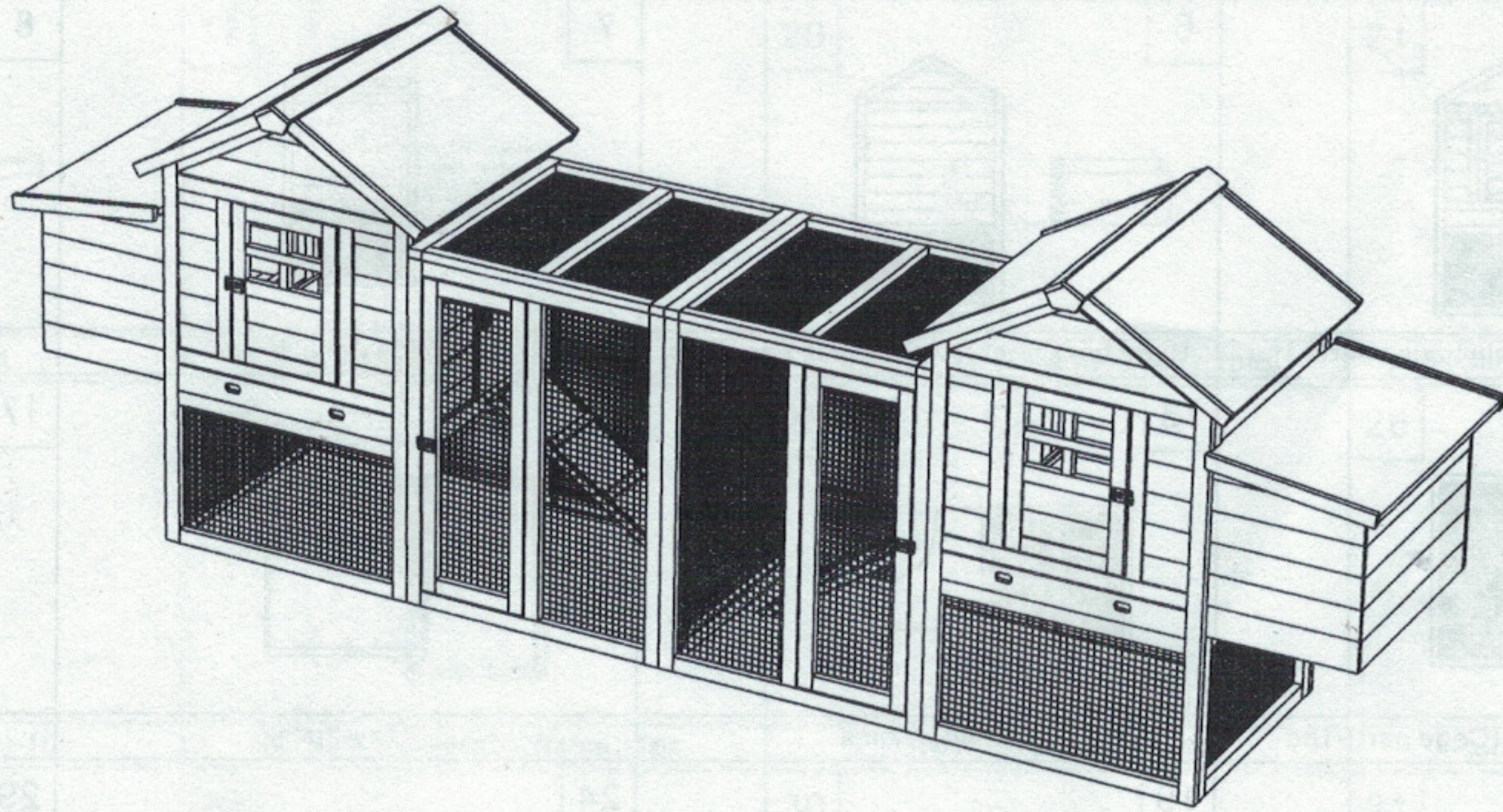

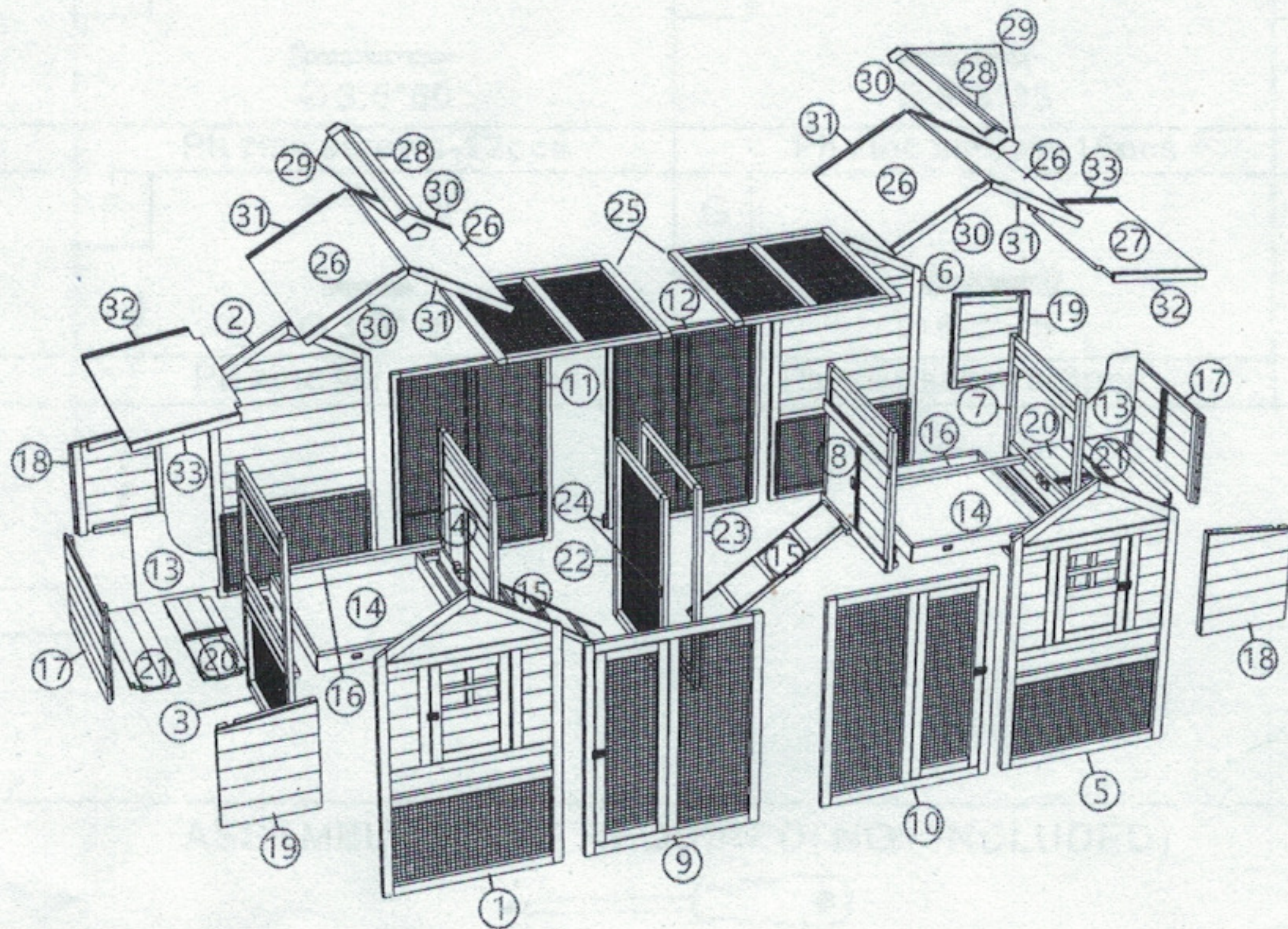





This set includes 2 boxes. If not receive full 2 boxes, please contact our customer service team.

Detail View

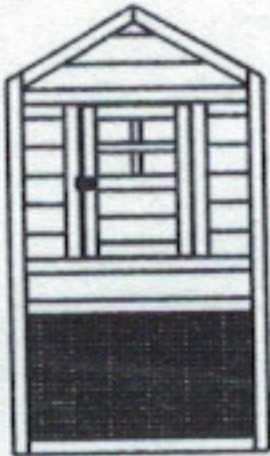
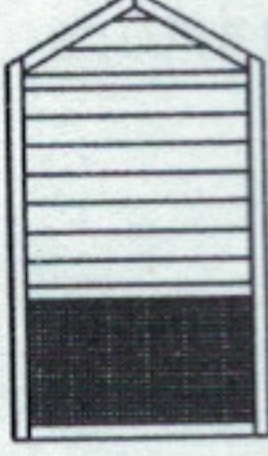
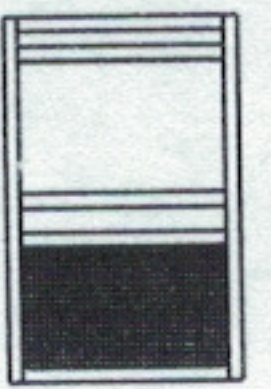
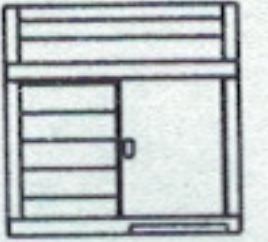
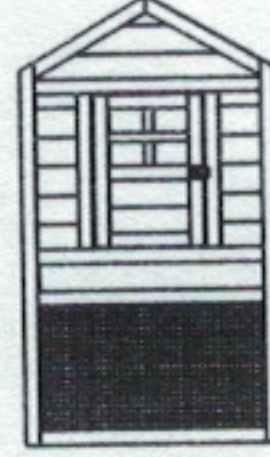
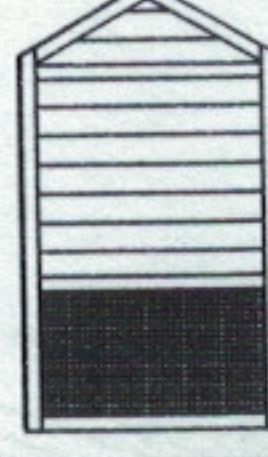
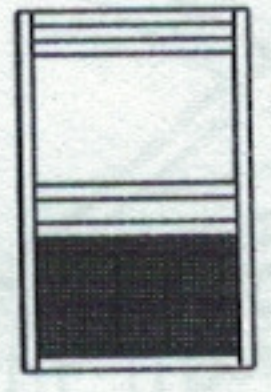
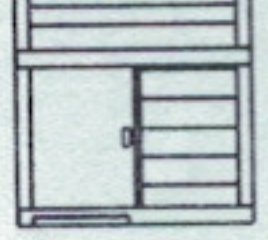
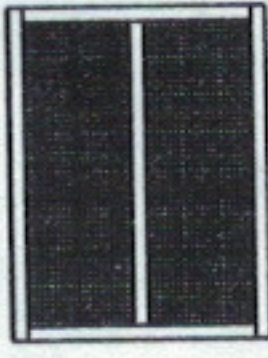
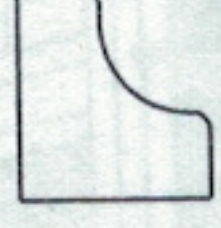

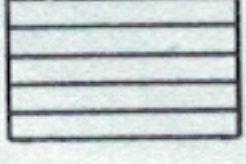
PLEASE BE CAREFUL DO NOT DAMAGE THE HOLE POSITION WHEN YOU USE POWER TOOLS

Part List

<p>1</p> 	<p>2</p> 	<p>3</p> 	<p>4</p> 
<p>Left front panel(Main house part)-1pc</p>	<p>Left back panel(Main house part)-1pc</p>	<p>Left side panel I-1pc</p>	<p>Right side panel I-1pc</p>
<p>5</p> 	<p>6</p> 	<p>7</p> 	<p>8</p> 
<p>Right front panel(Main house part)-1pc</p>	<p>Right back panel(Main house part)-1pc</p>	<p>Left side panel II-1pc</p>	<p>Right side panel II-1pc</p>
<p>12</p> 	<p>13</p> 	<p>14</p> 	<p>17</p> 
<p>Right back panel(Cage part)-1pc</p>	<p>Divider-2pcs</p>	<p>Tray-2pcs</p>	<p>Front panel(Nesting box)-1pc</p>
<p>18</p> 	<p>19</p> 	<p>24</p> 	<p>29</p> 
<p>Side panel I(Nesting box)-2pcs</p>	<p>Side panel II(Nesting box)-2pcs</p>	<p>Wood knob-2pcs</p>	<p>Wooden block(Main house part)-4pcs</p>

9		10		11		15	
Left front panel(Cage part)-1pc		Right front panel(Cage part)-1pc		Left back panel(Cage part)-1pc		Ladder-2pcs	
16		17		20		21	
Wood perch-2pcs		Front panel(Nesting box)-1pc		Bottom panel(Nesting box)-2pcs		Bottom panel(Nesting box)-2pcs	
22		23		25		26	
Side panel(Mesh door)-1pc		Side panel(wooden frame)-1pc		Roof(Cage part)-2pcs		Roof(Main house part)-4pcs	
27		28		30		31	
Roof(Nesting box)-2pcs		Wooden roof cap(Main house part)-2pcs		Part I-Wooden frame of roof(Cage part)-4pcs		Part II-Wooden frame of roof(Cage part)-4pcs	
33		32					
Part I-Wooden frame of roof(Nesting box)-2pcs		Part II-Wooden frame of roof(Nesting box)-2pcs					

Hardware List

A		B		C		D	
Ph zinc screws-32pcs		Ph zinc screws-12pcs		Ph zinc screws-16pcs		Ph zinc screws-50pcs	
E		F		G		H	
Ph zinc screws-12pcs		Ph zinc screws-20pcs		Ph zinc screws-8pcs		Wood dowel-8pcs	
R							
Right check strap-2pcs							

ASSEMBLY TOOLS REQUIRED(NOT INCLUDED)

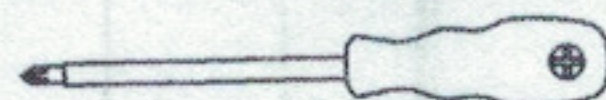

PLEASE BE CAREFUL DO NOT DAMAGE THE HOLE POSITION WHEN YOU USE POWERTOOLS !

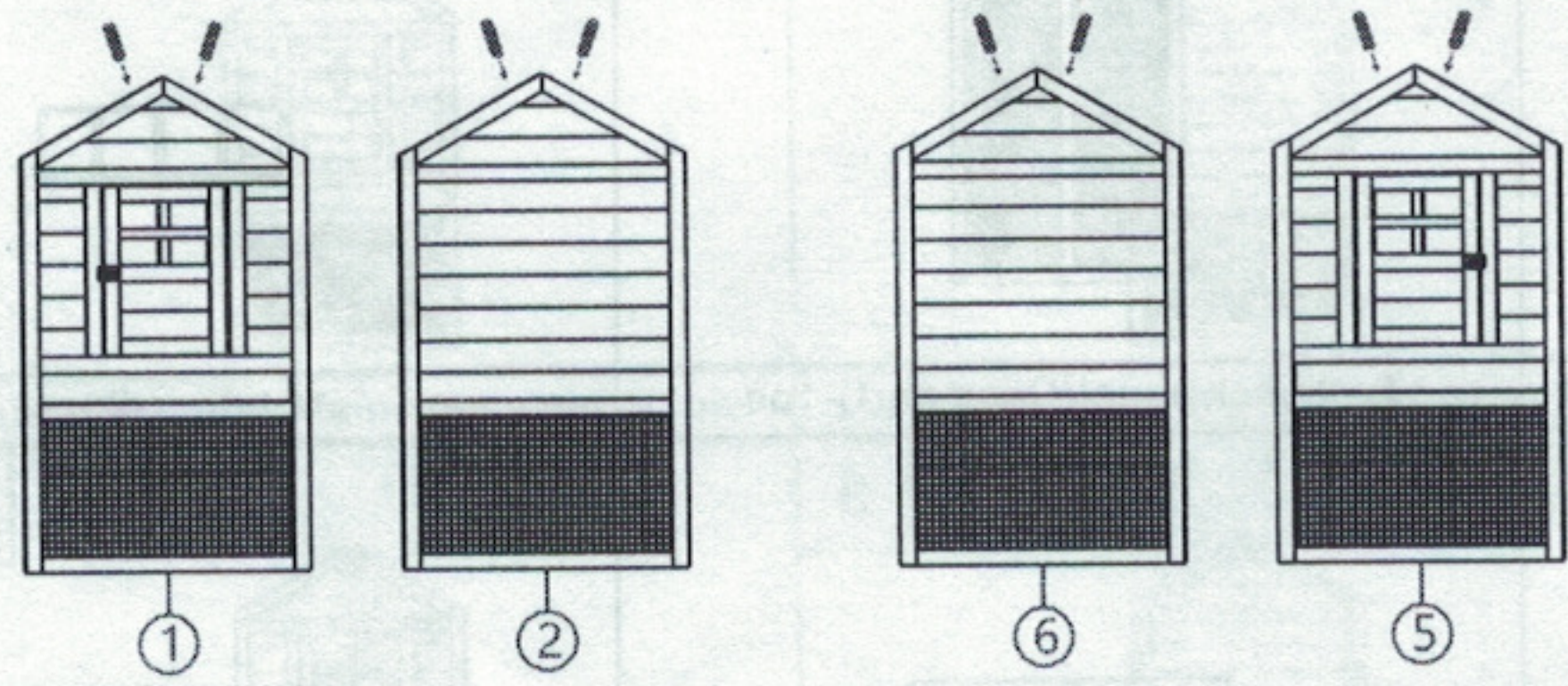

H*8

Step 1

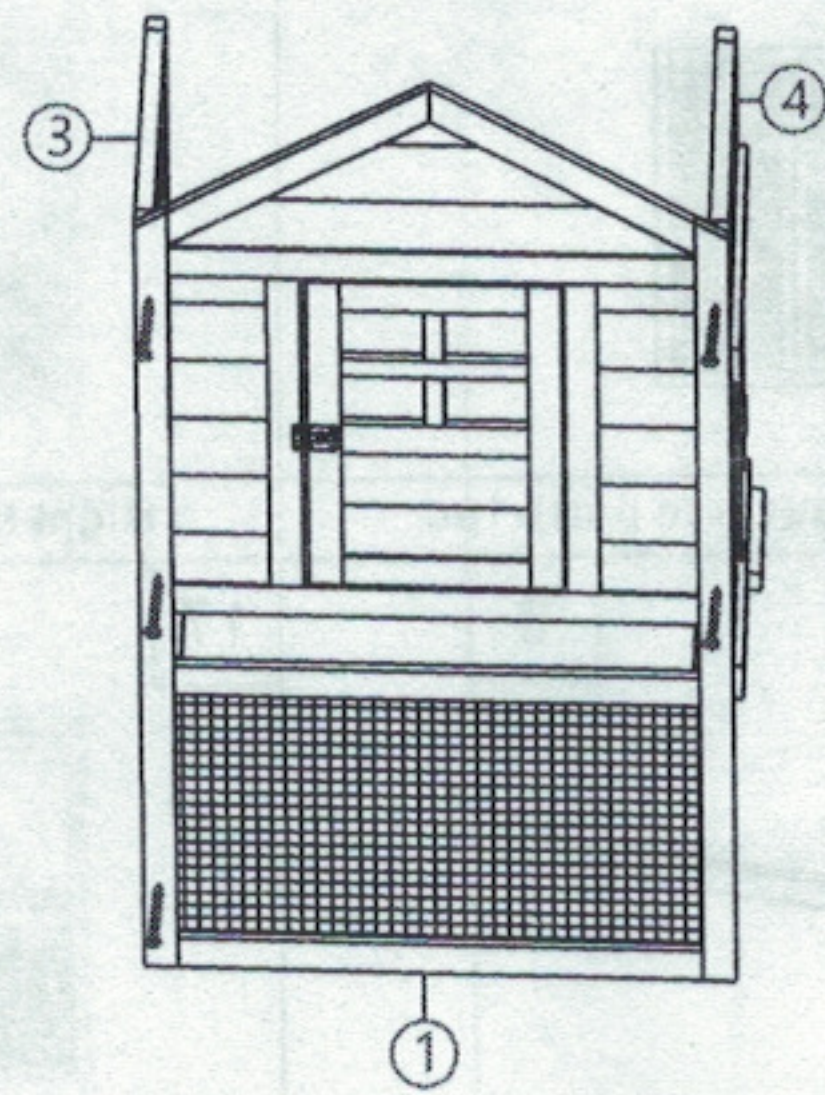

A*5

Step 2

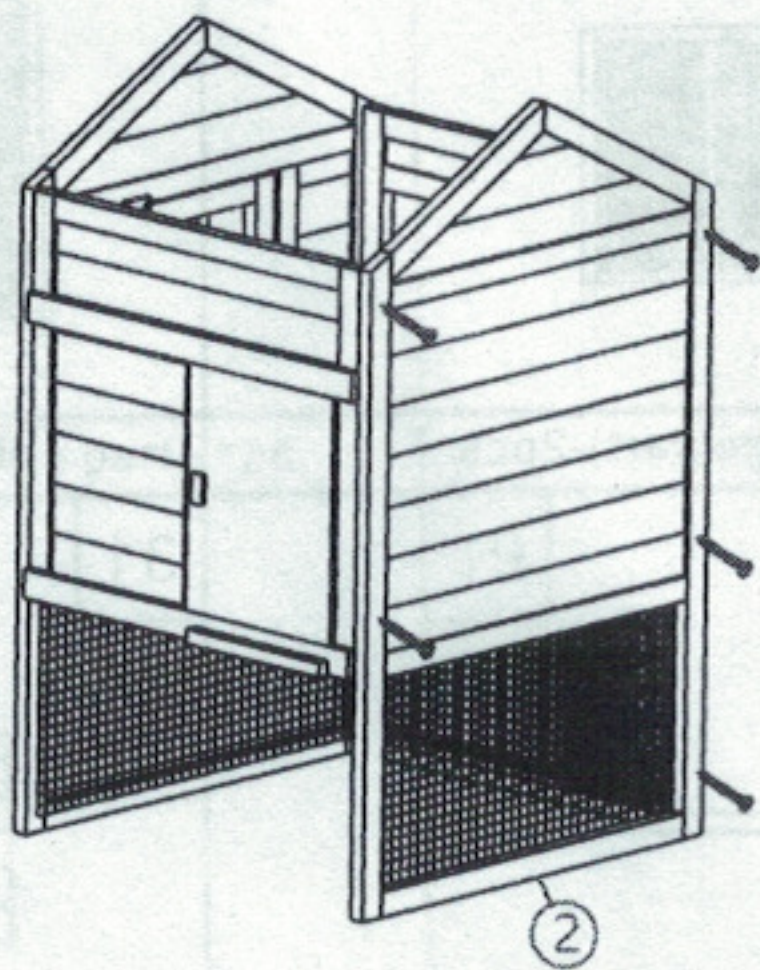

A*5

Step 3

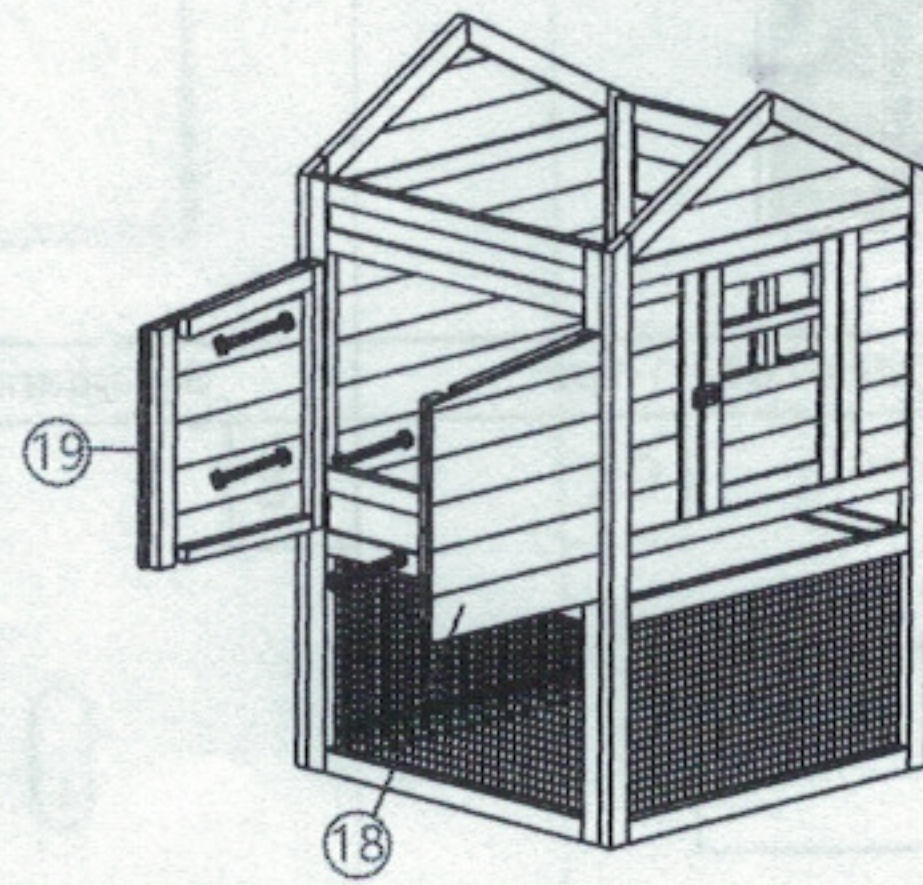

G*4

Step 4

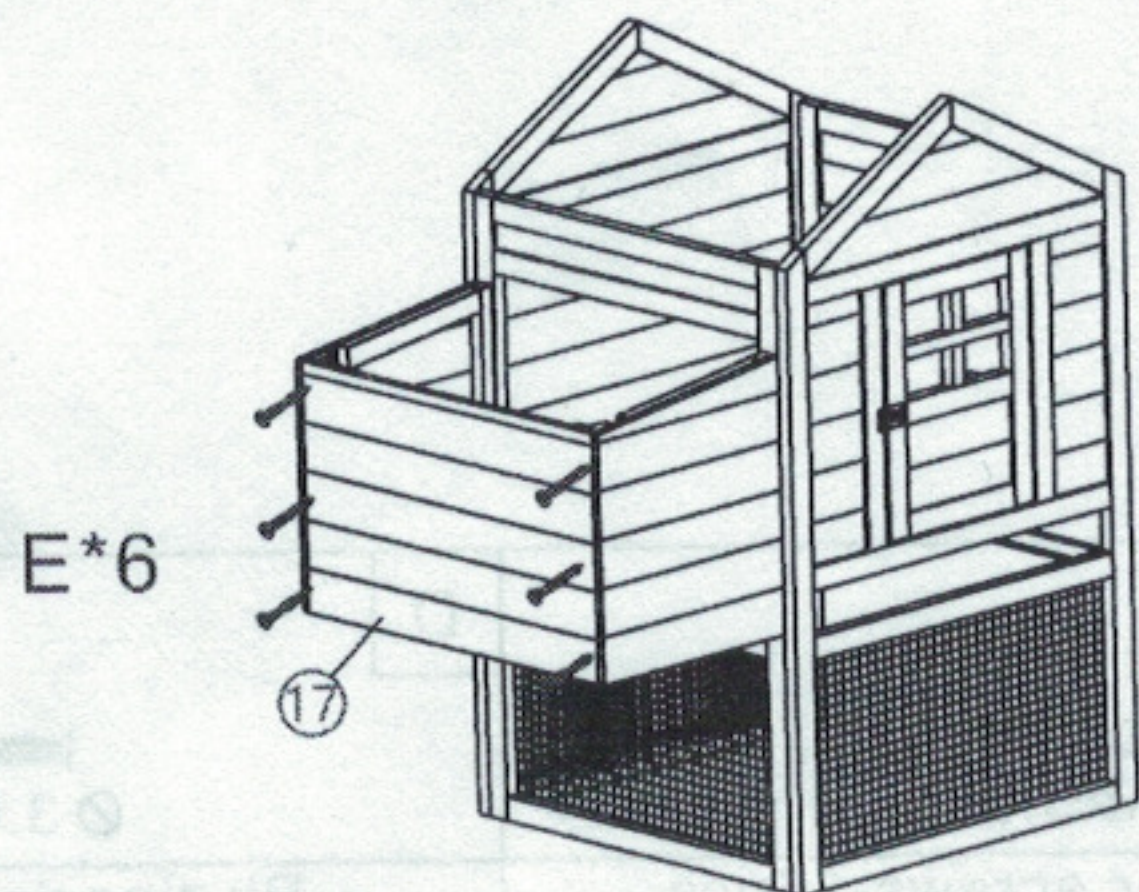

E*6

Step 5

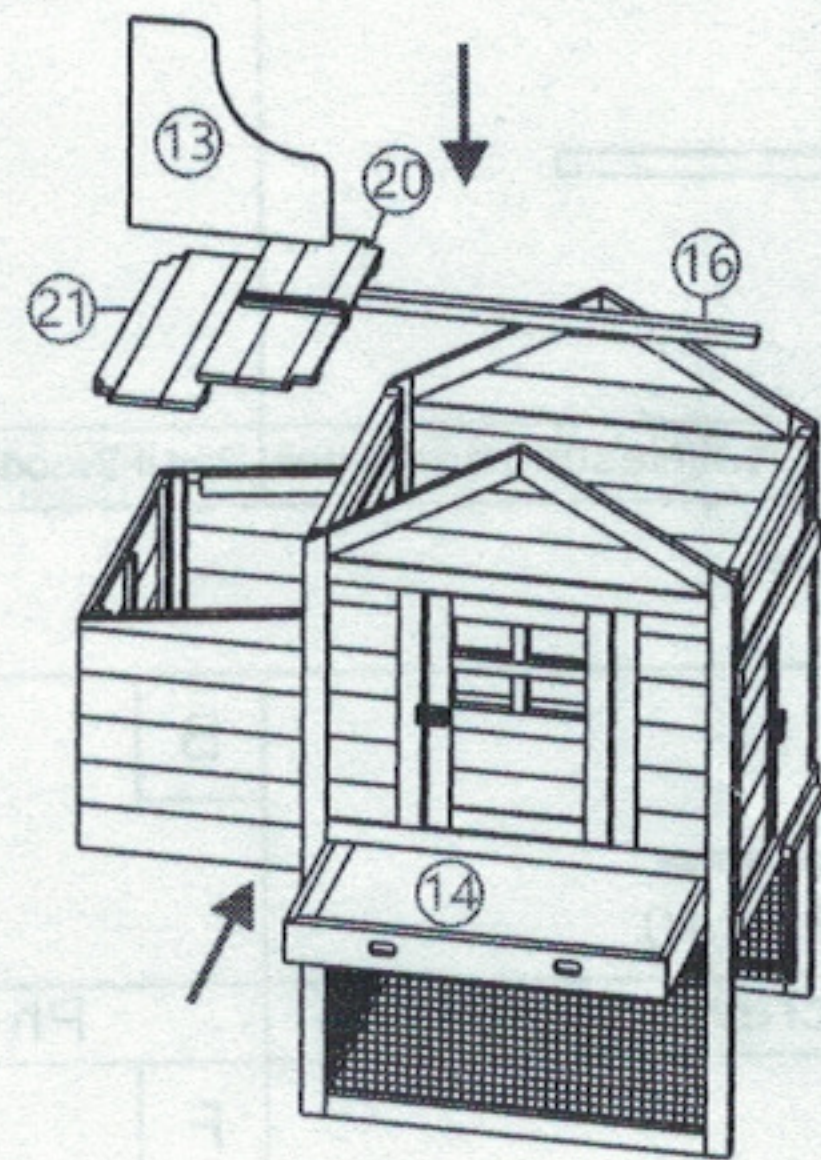

Step 6

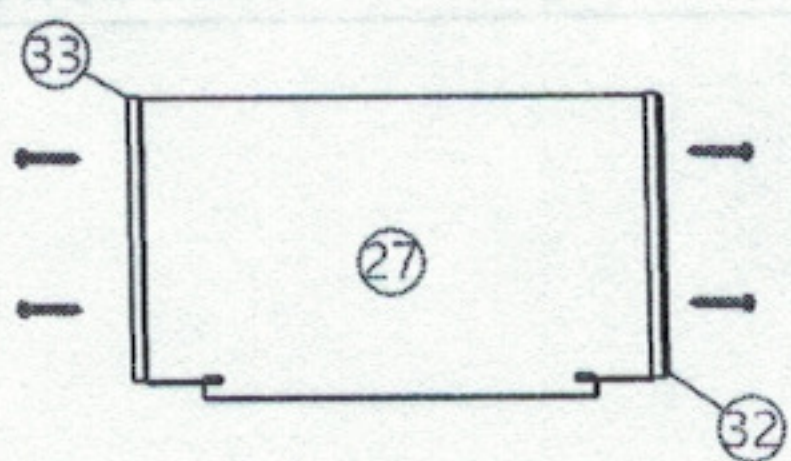

D*8

Step 7

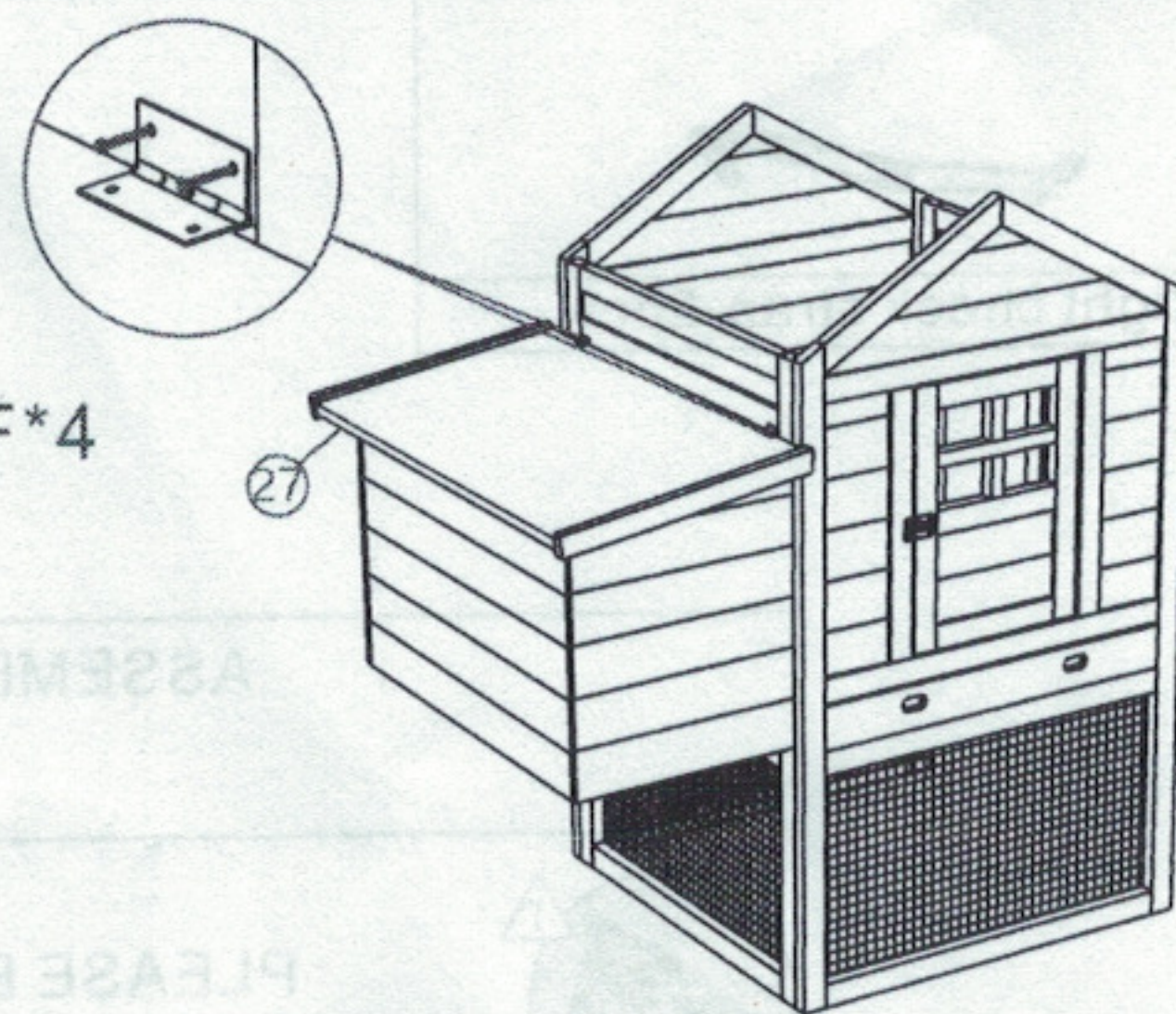

F*4

Step 8

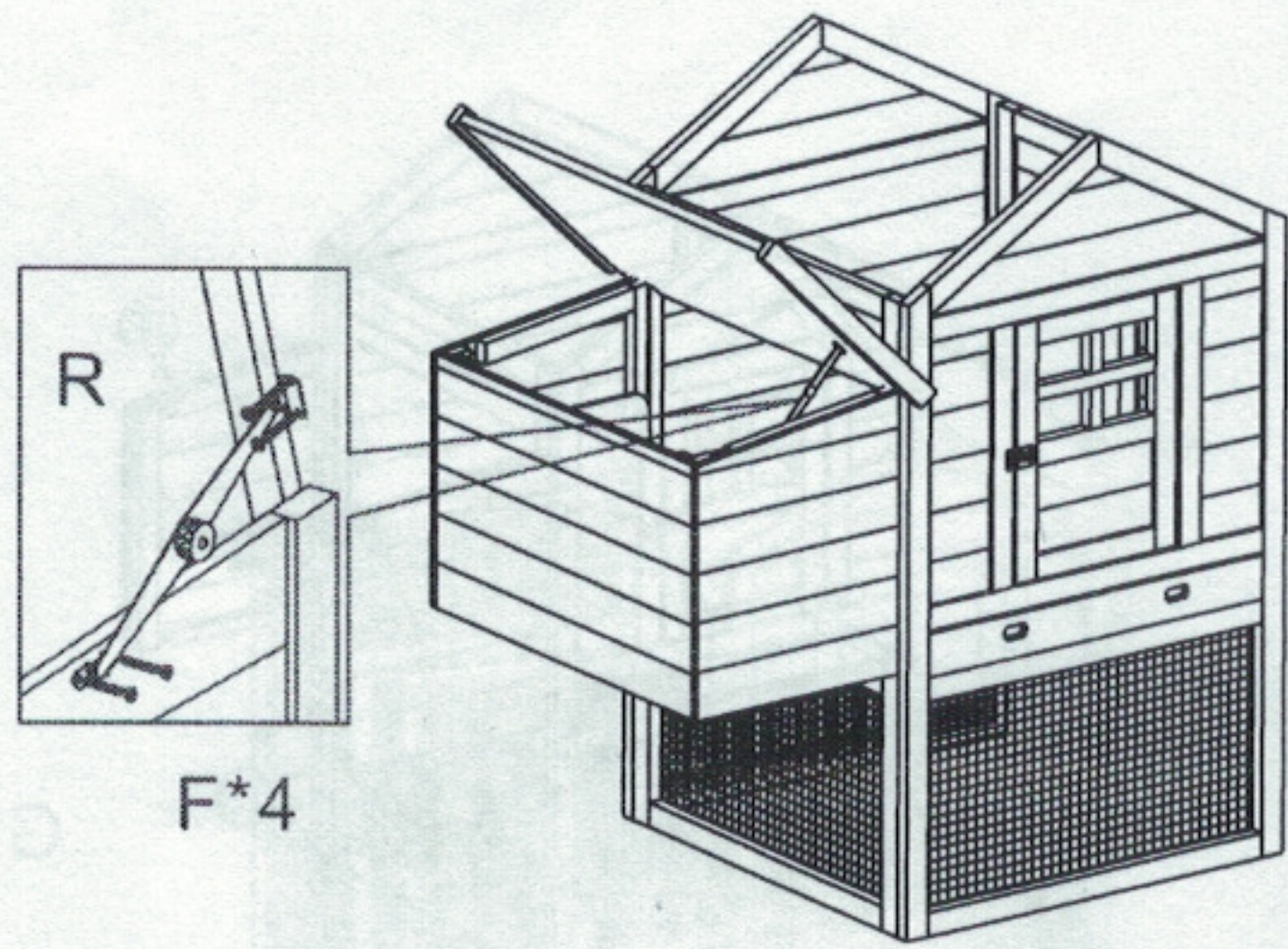

Step 9

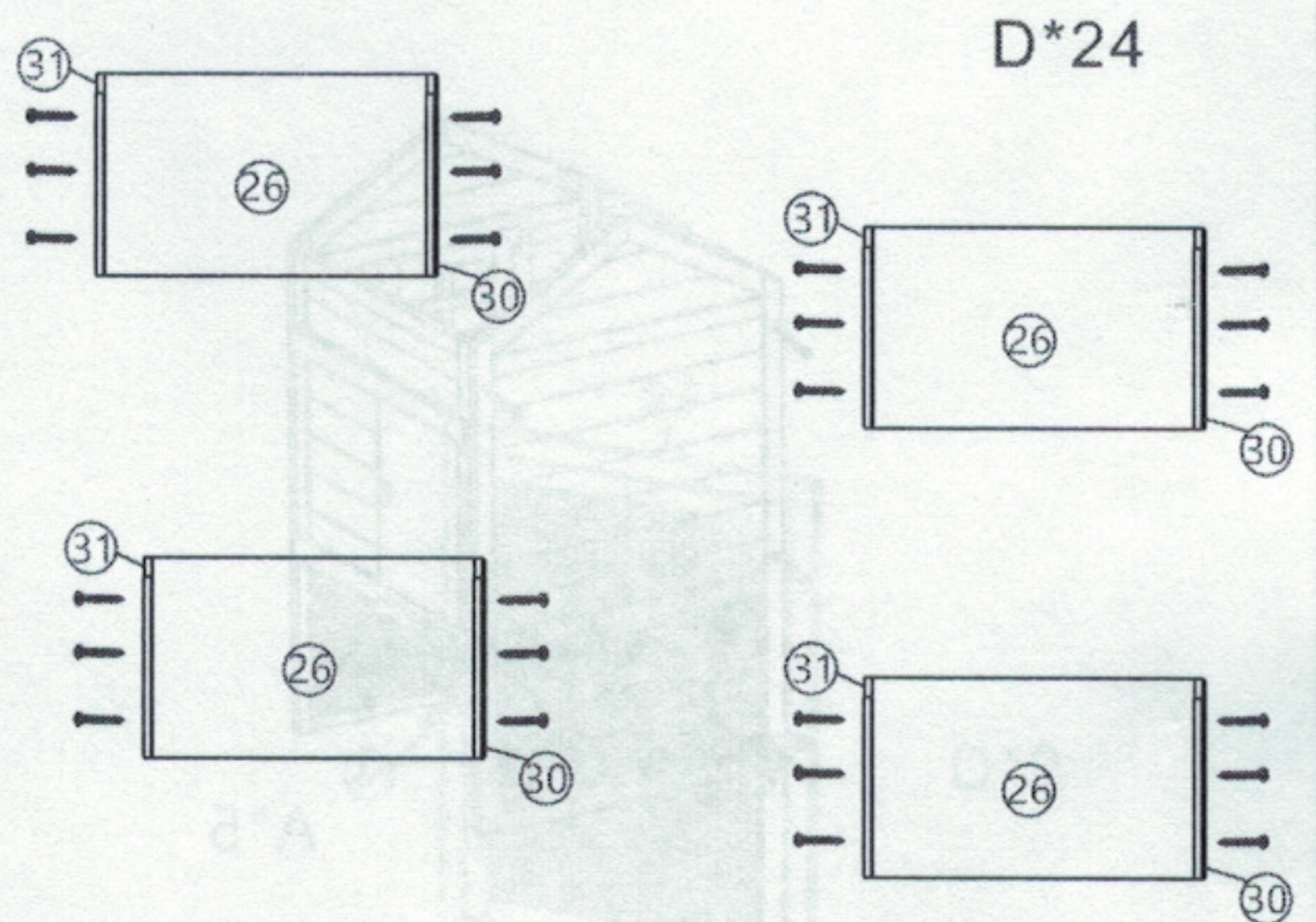

Step 10

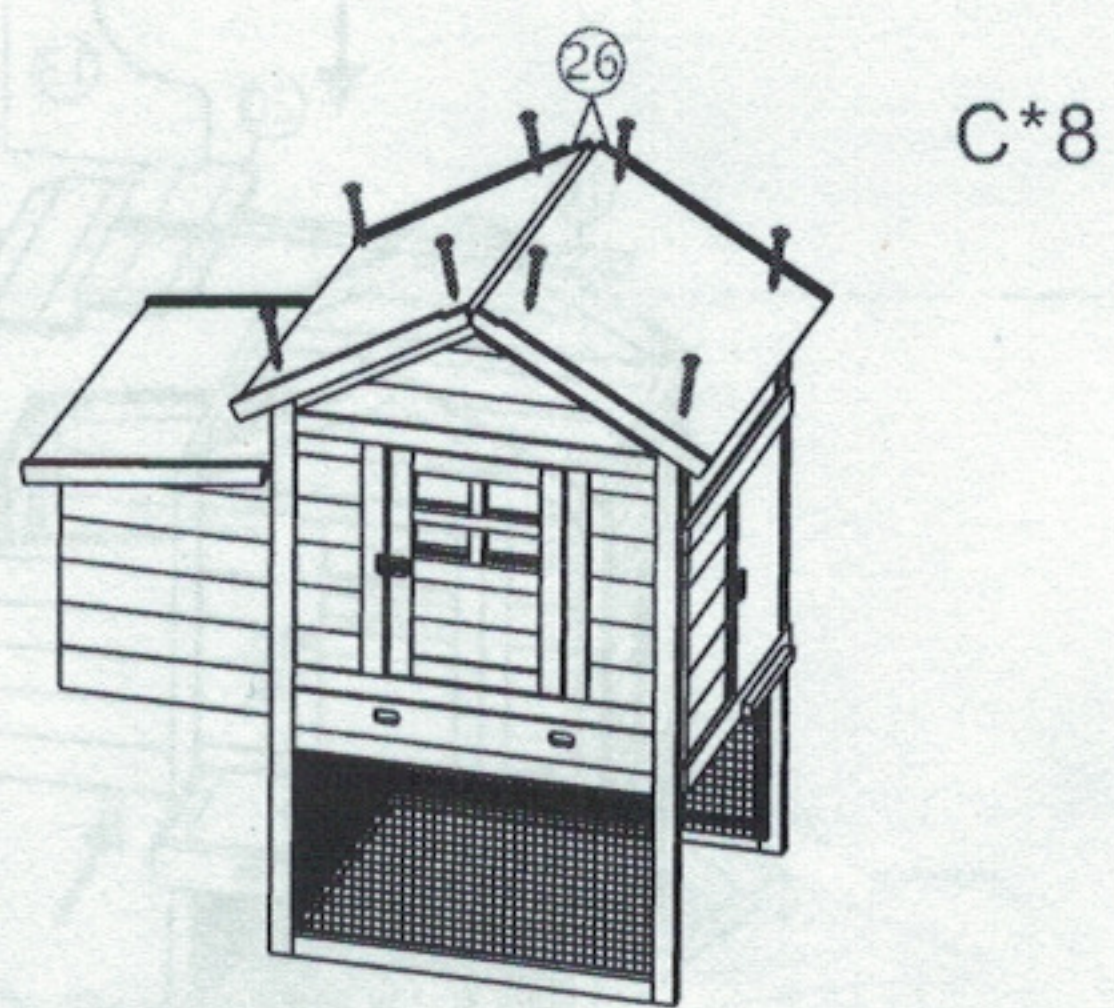

Step 11

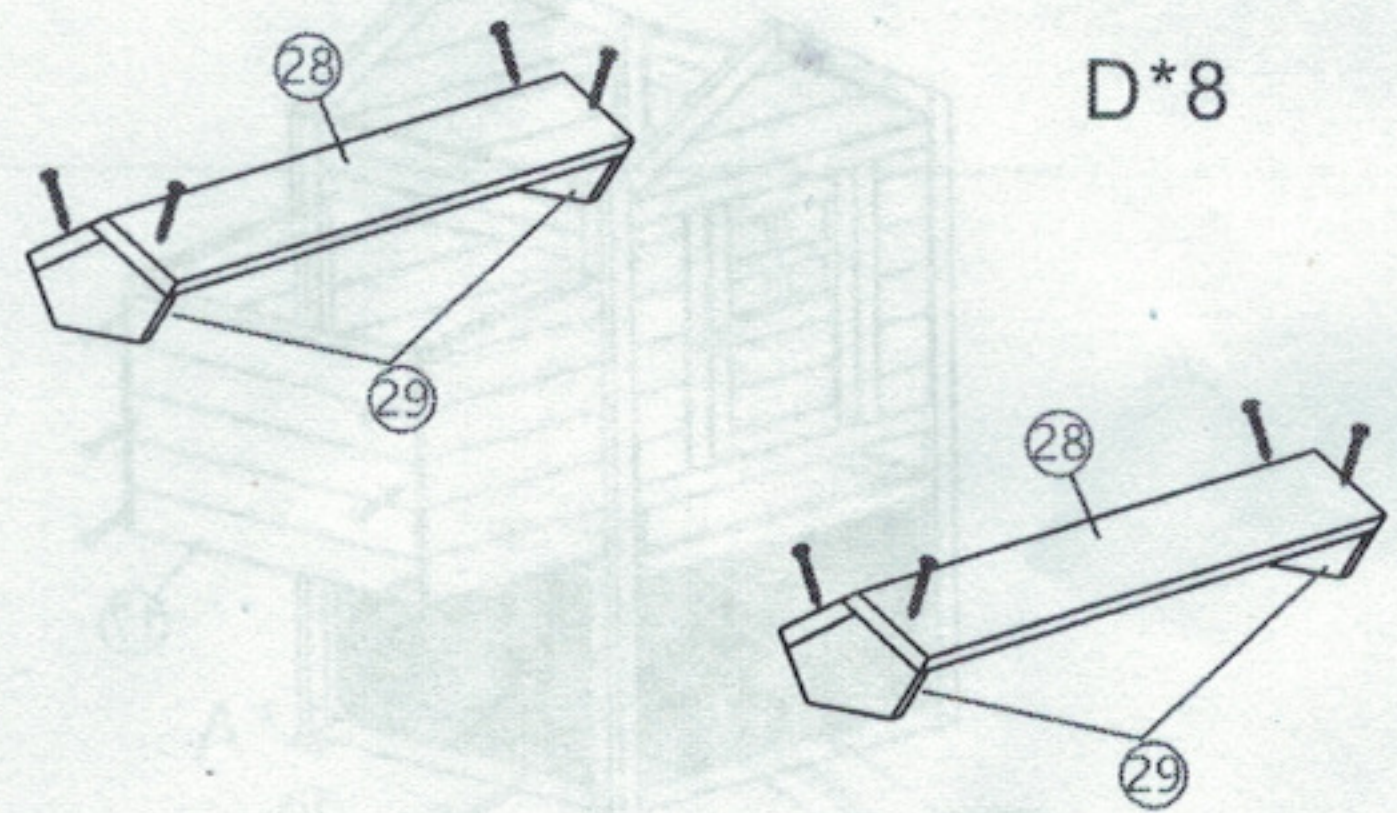

Step 12

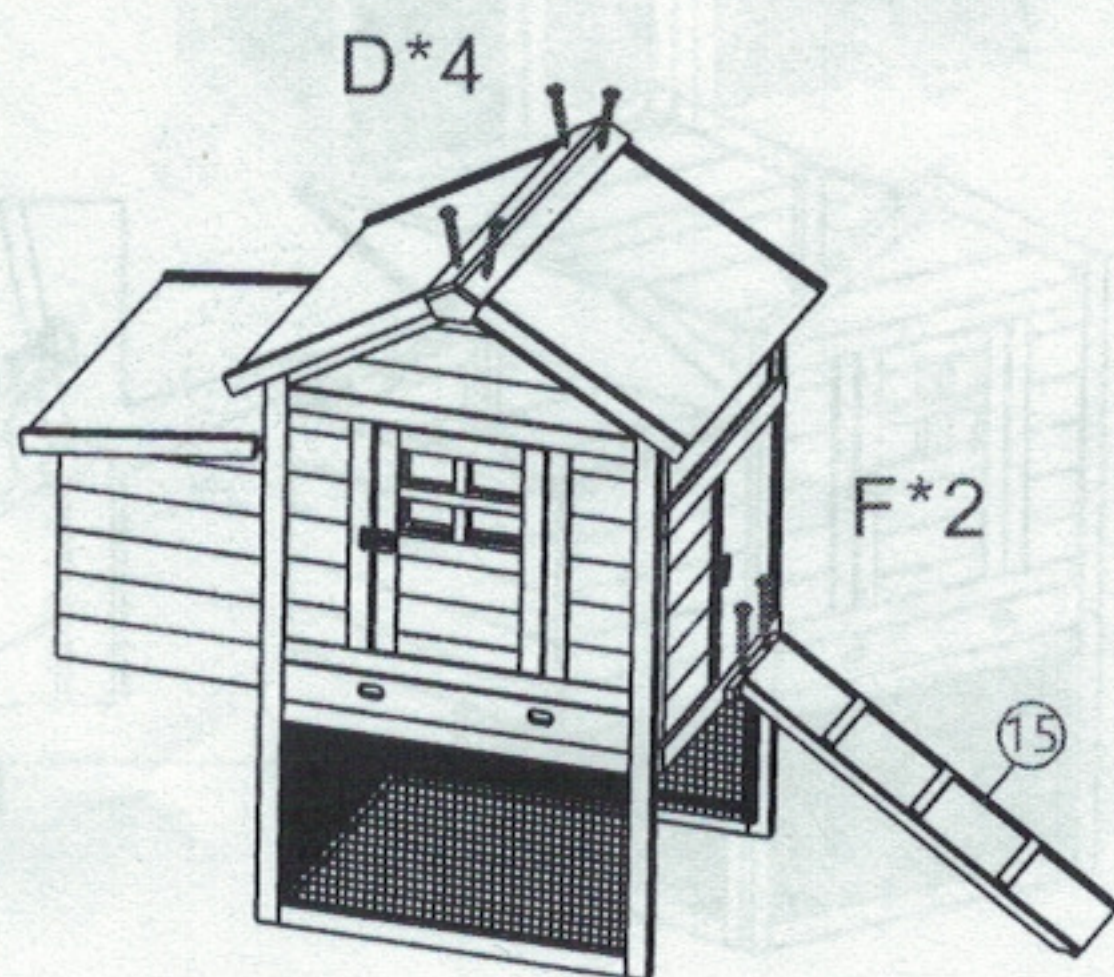

Step 13

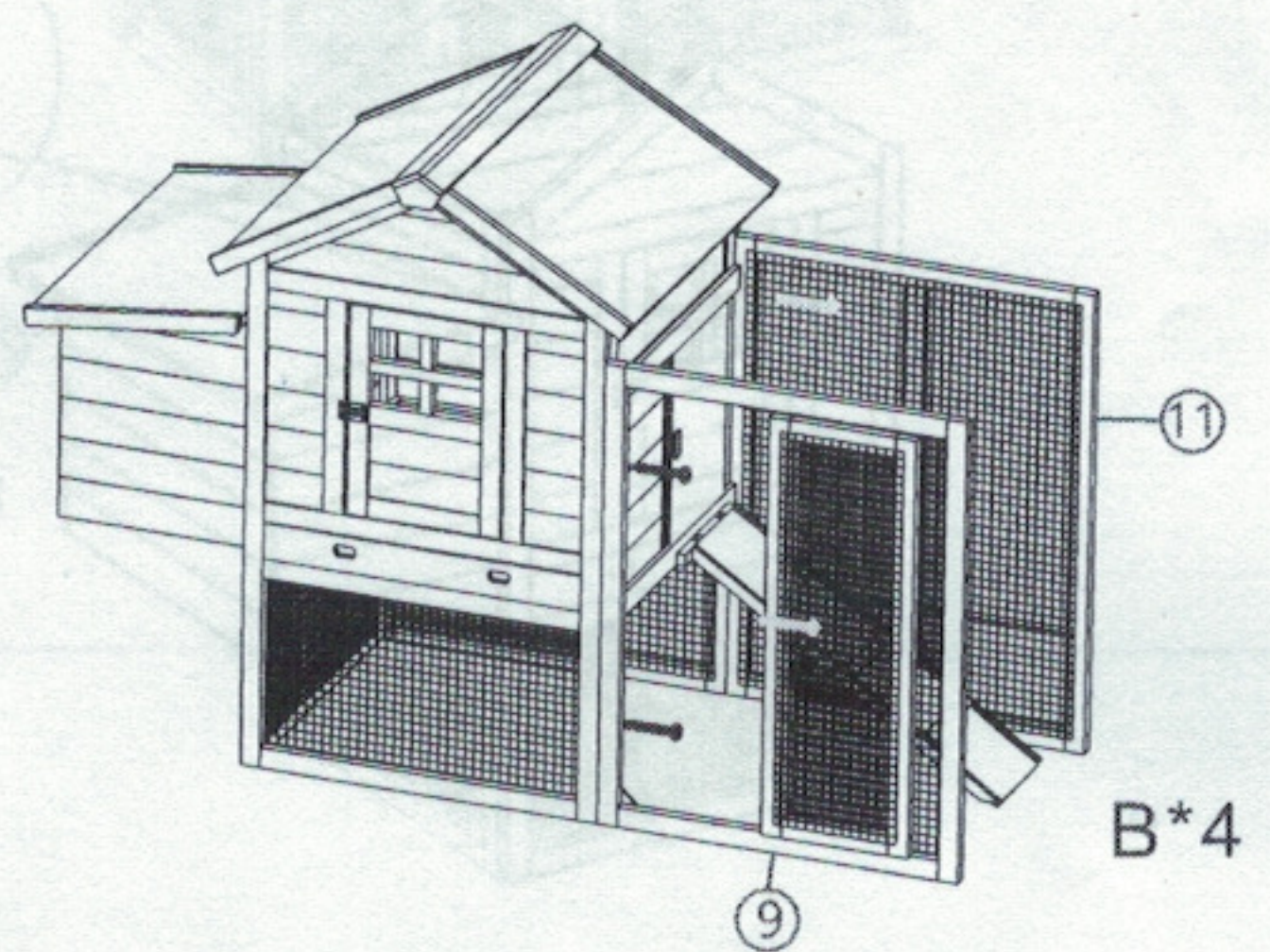

Step 14

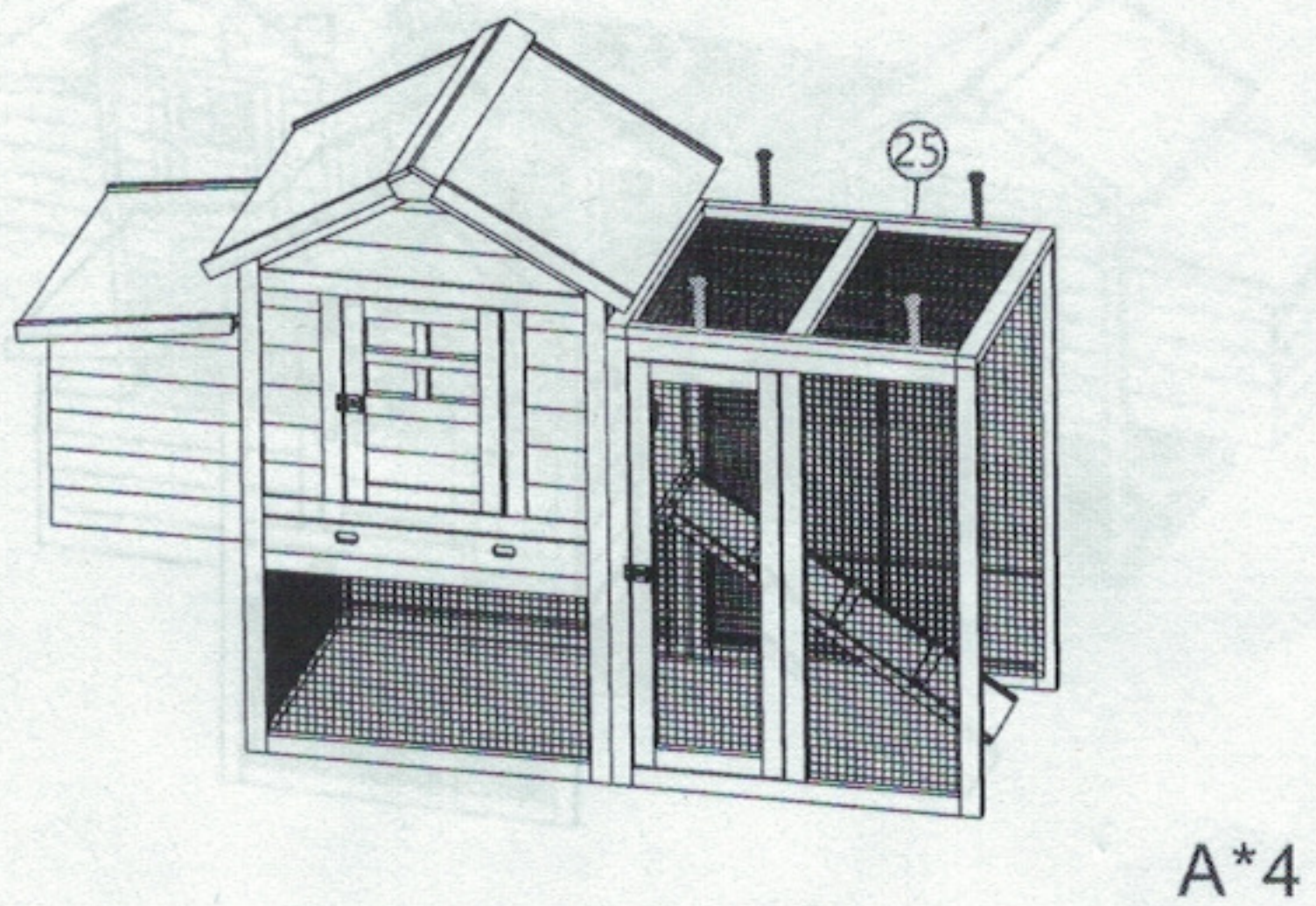

Step 15

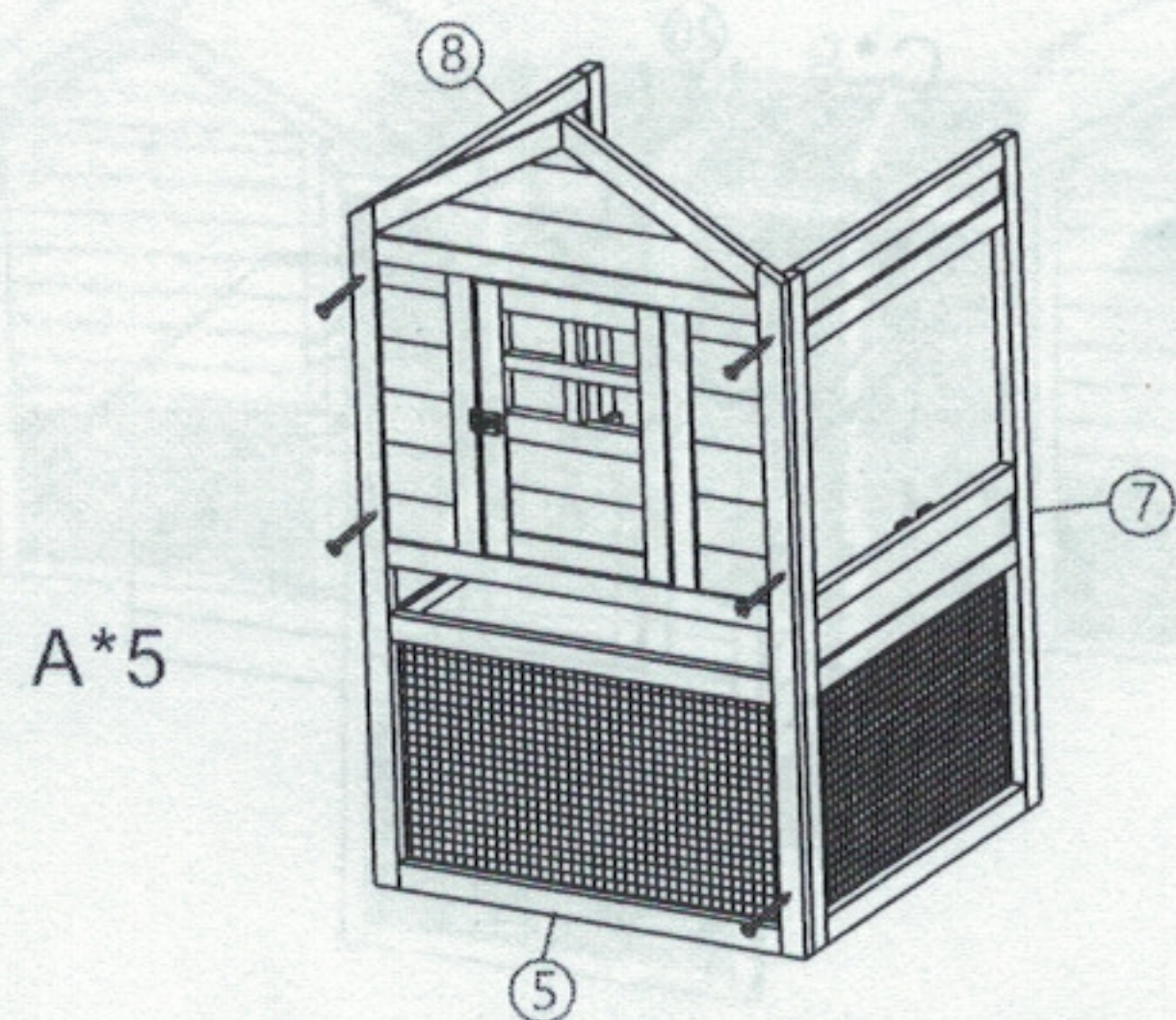

Step 16

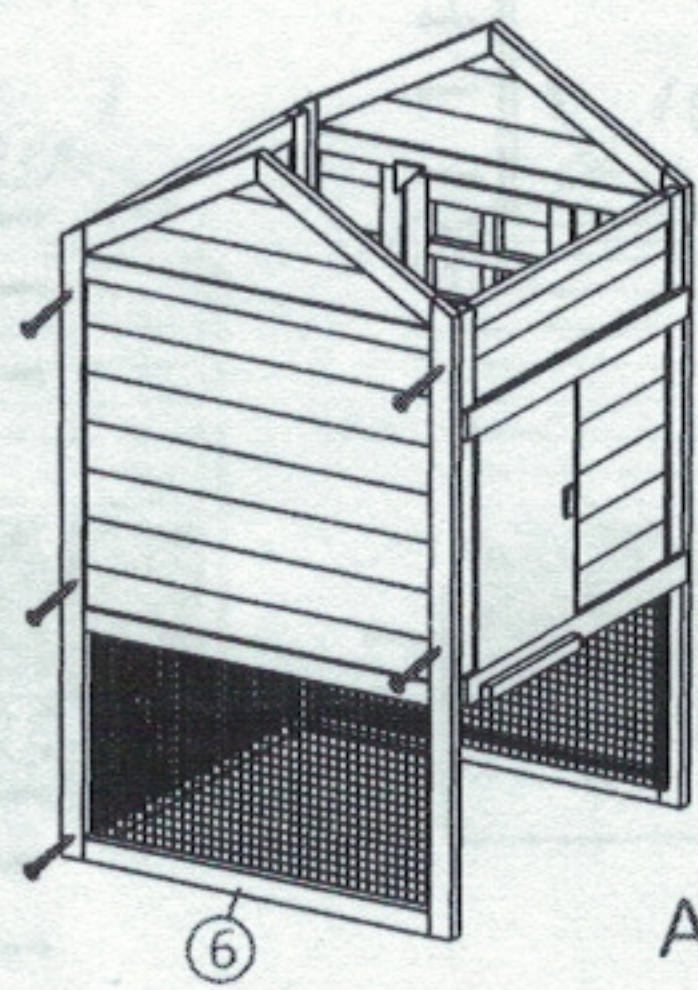

A*5

Step 17

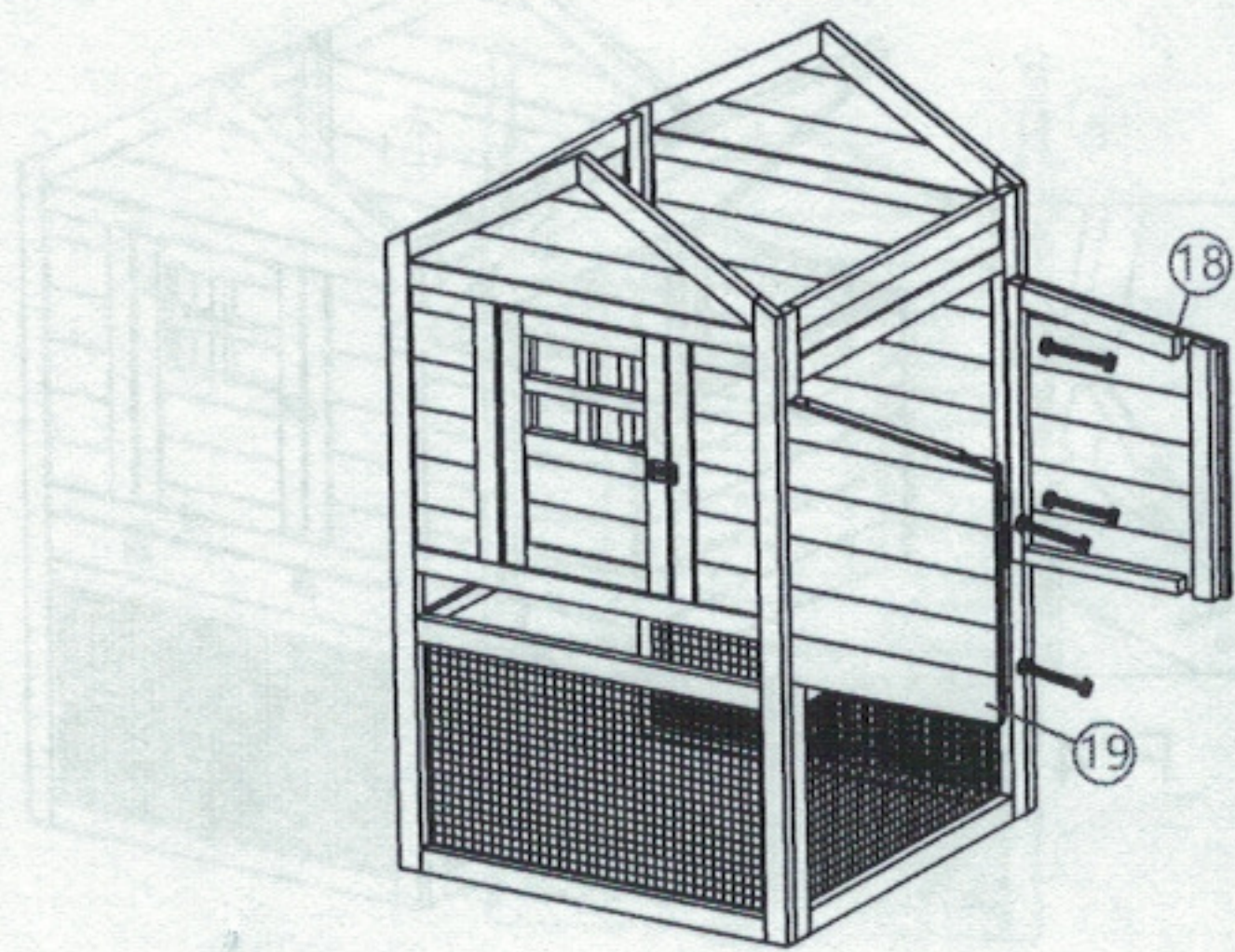

G*4

Step 18

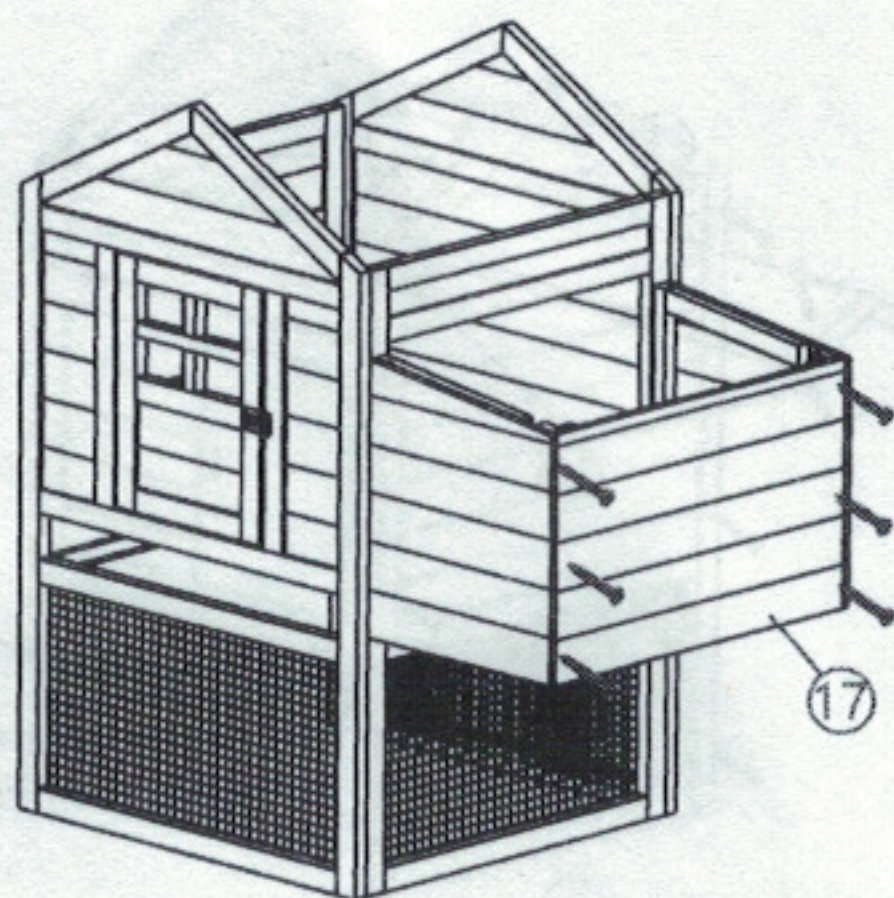

E*6

Step 19

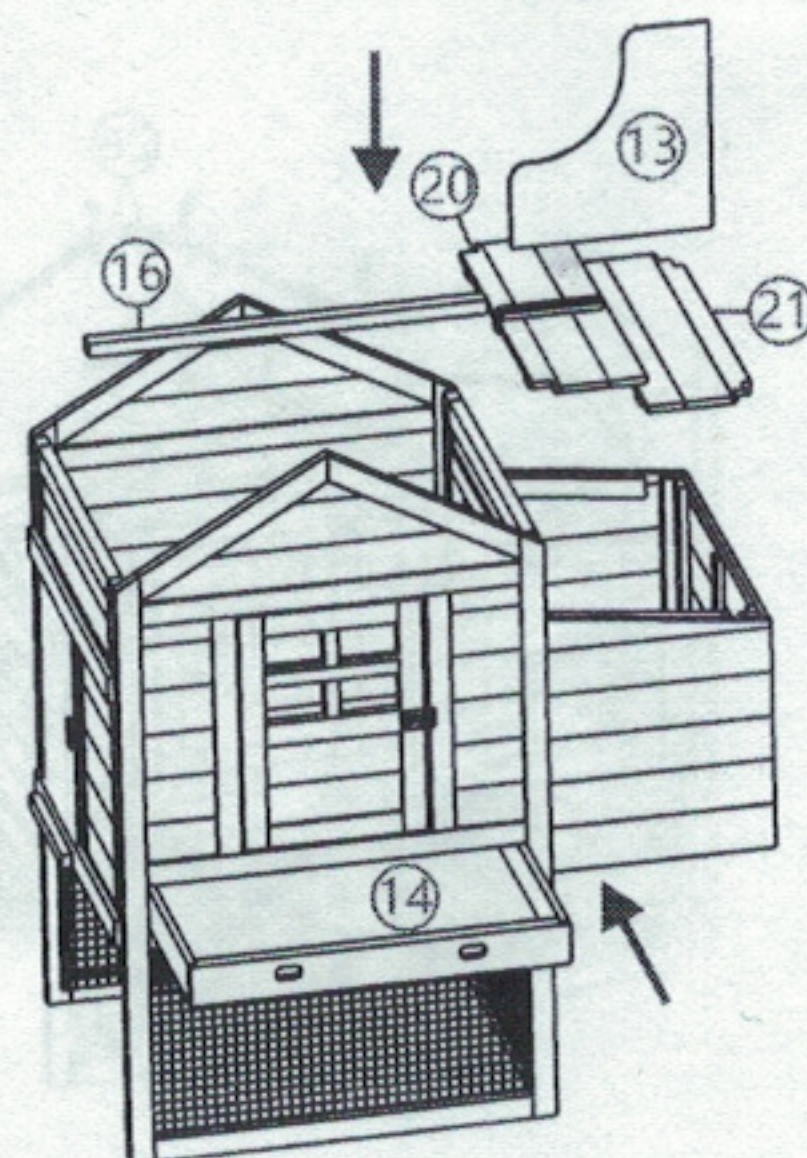

Step 20

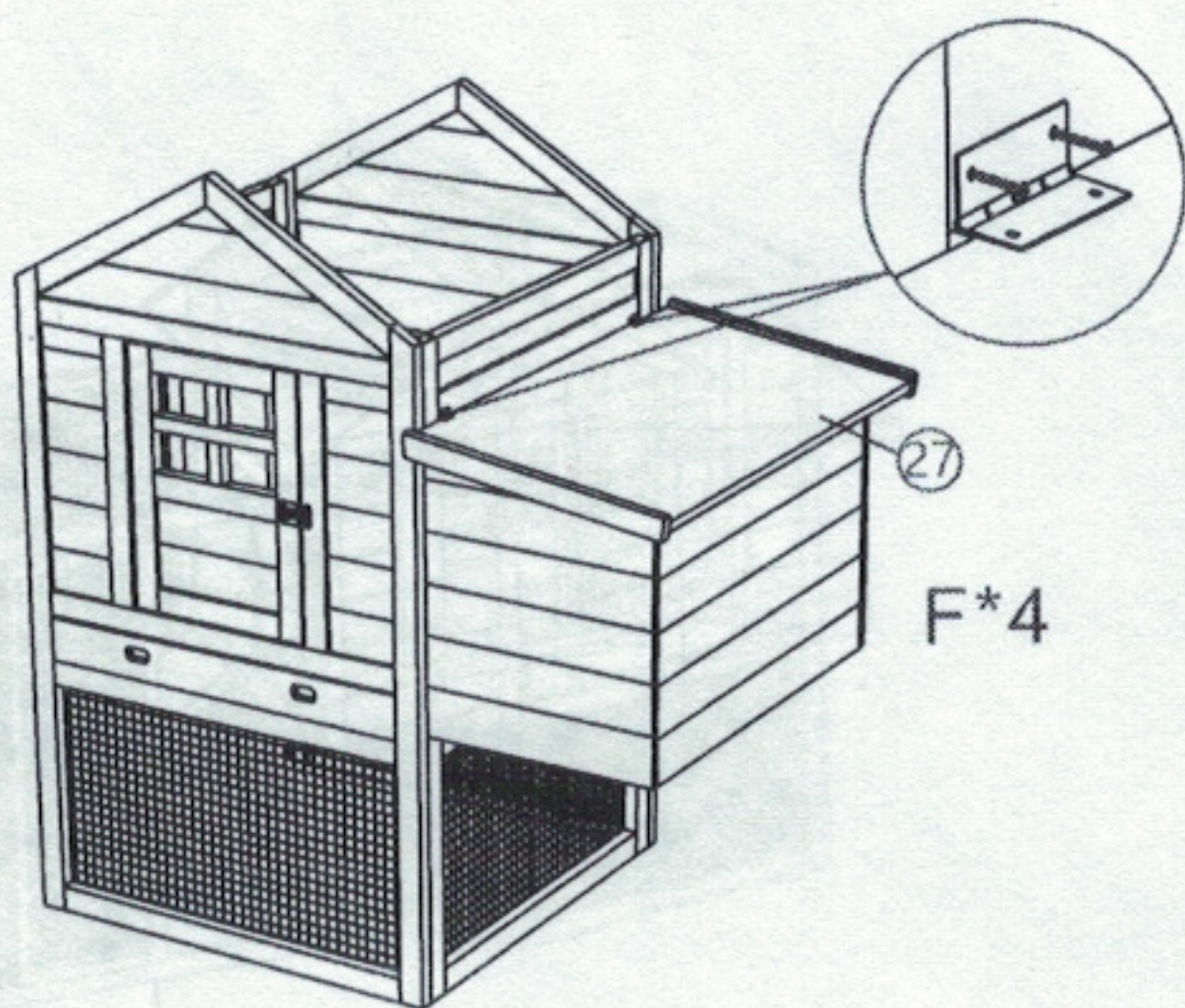

F*4

Step 21

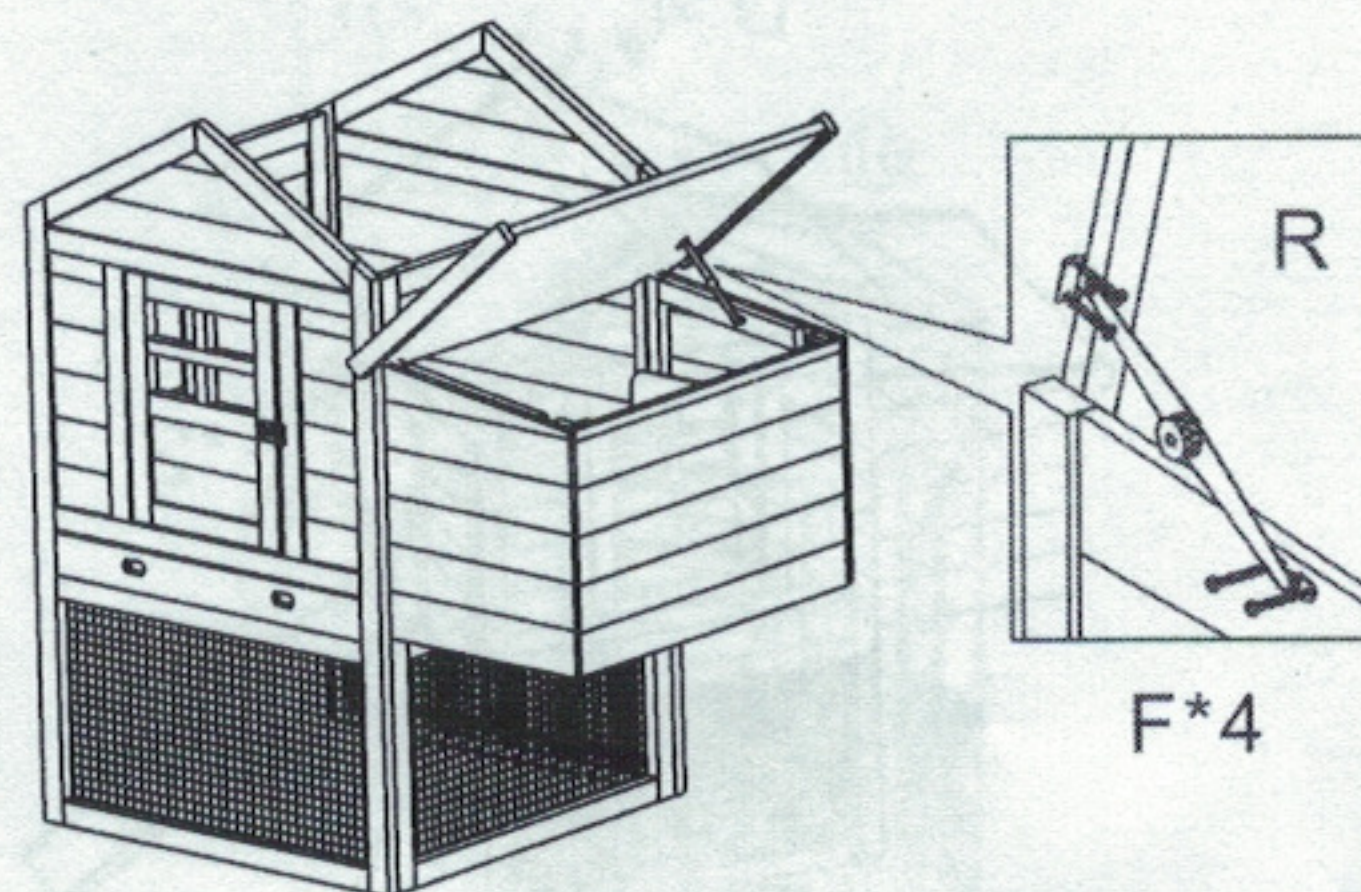

F*4

Step 22

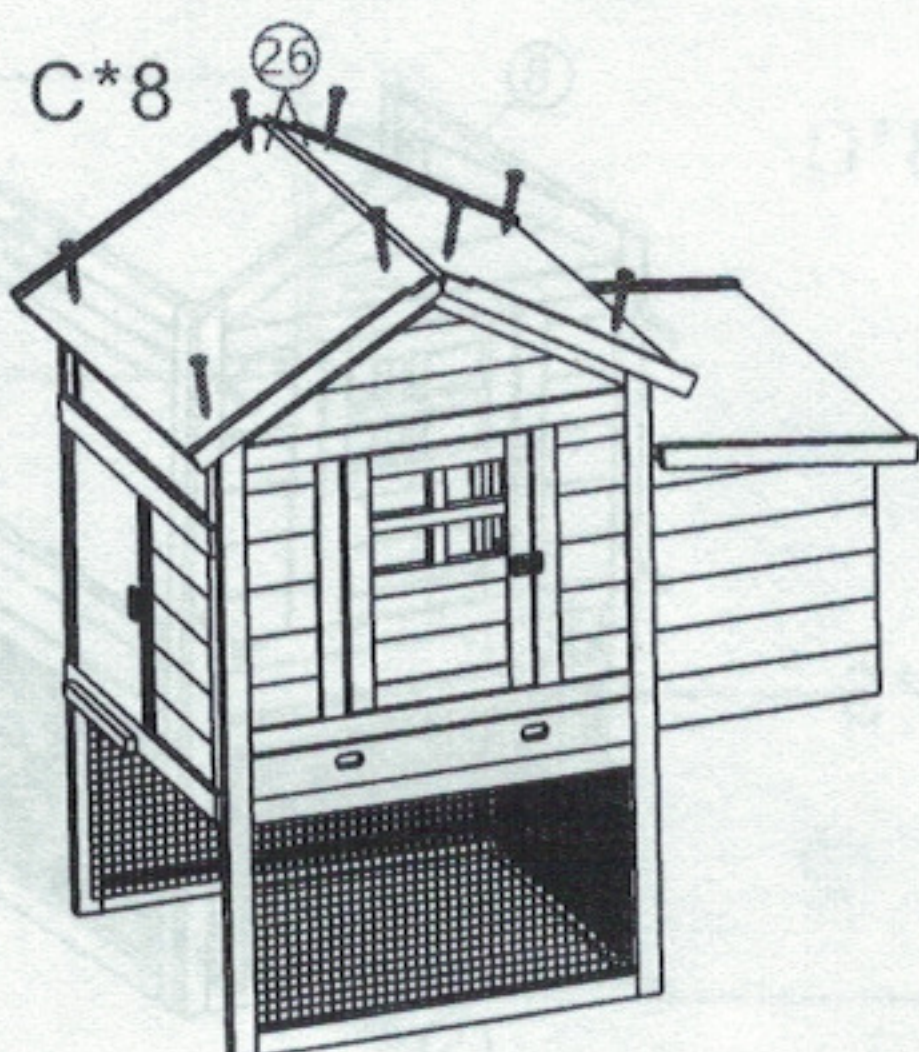

C*8

Step 23

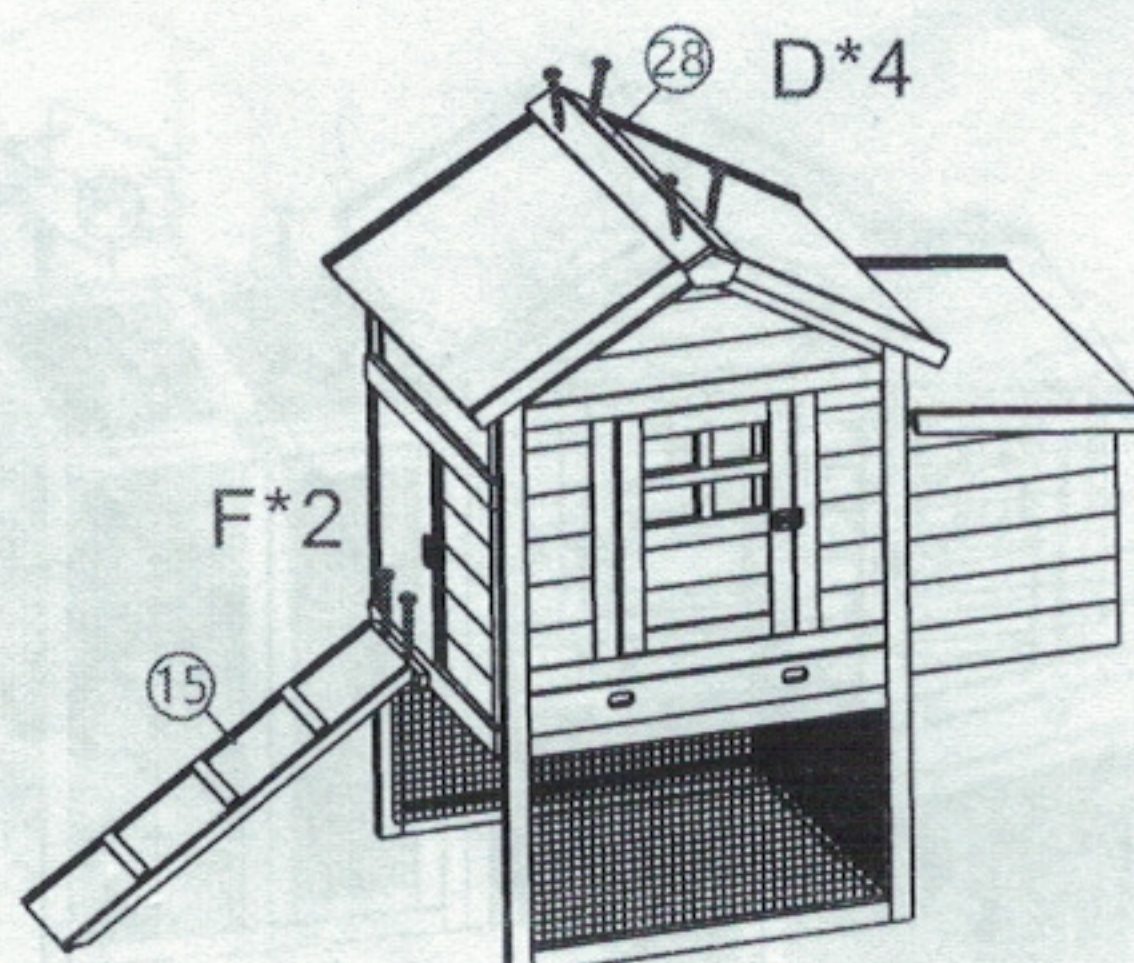

D*4

F*2

Step 24

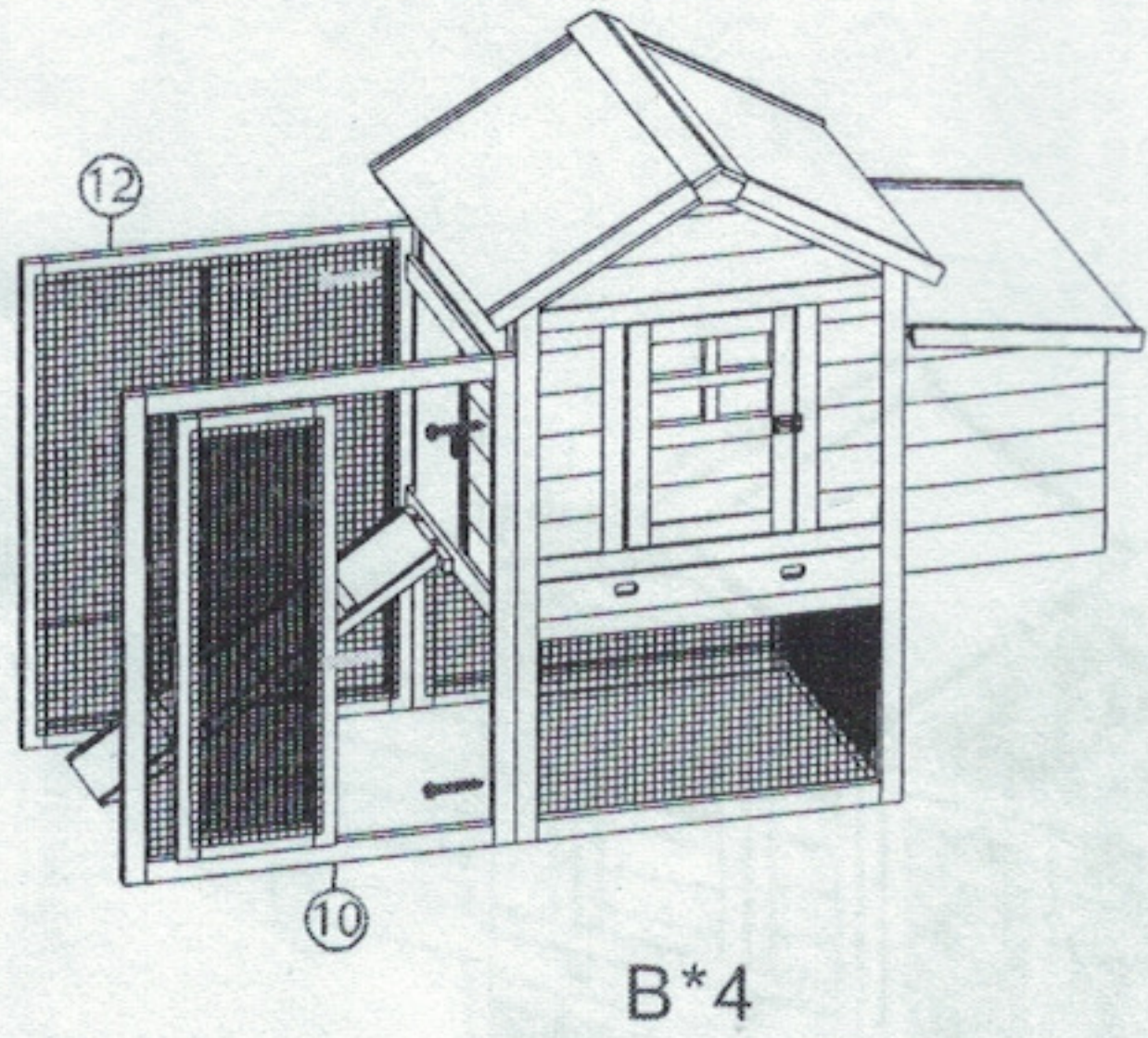

Step 25

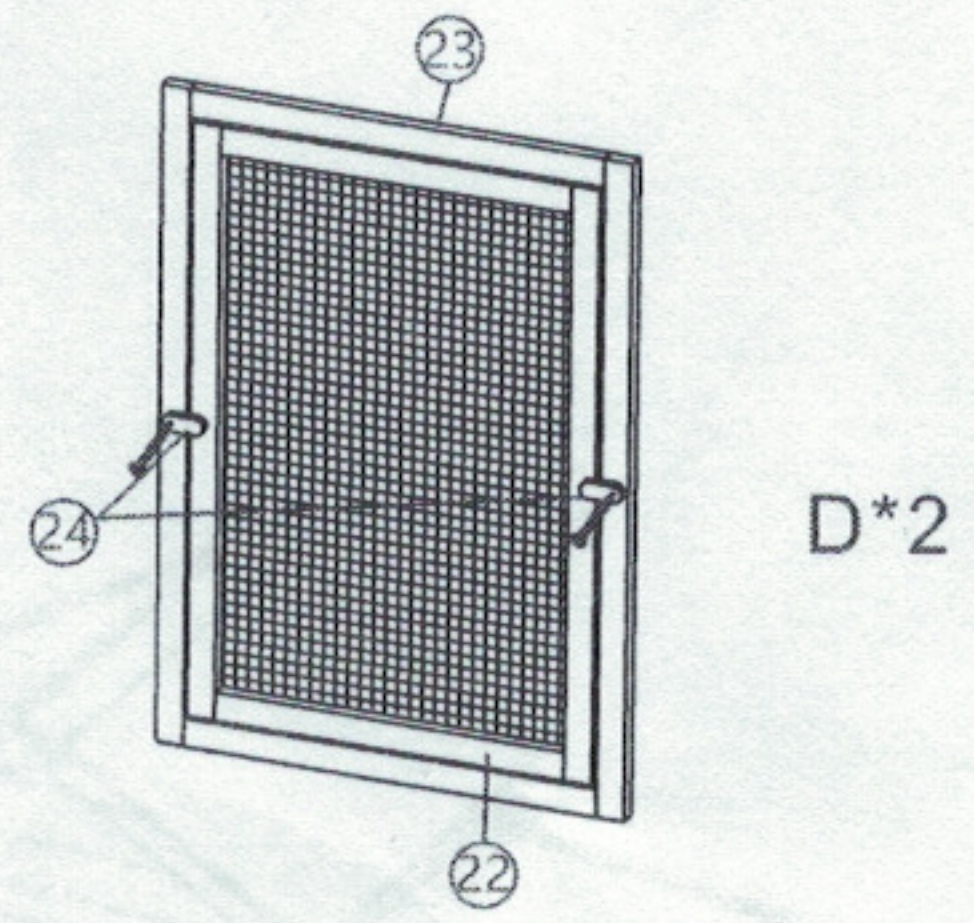

Step 26

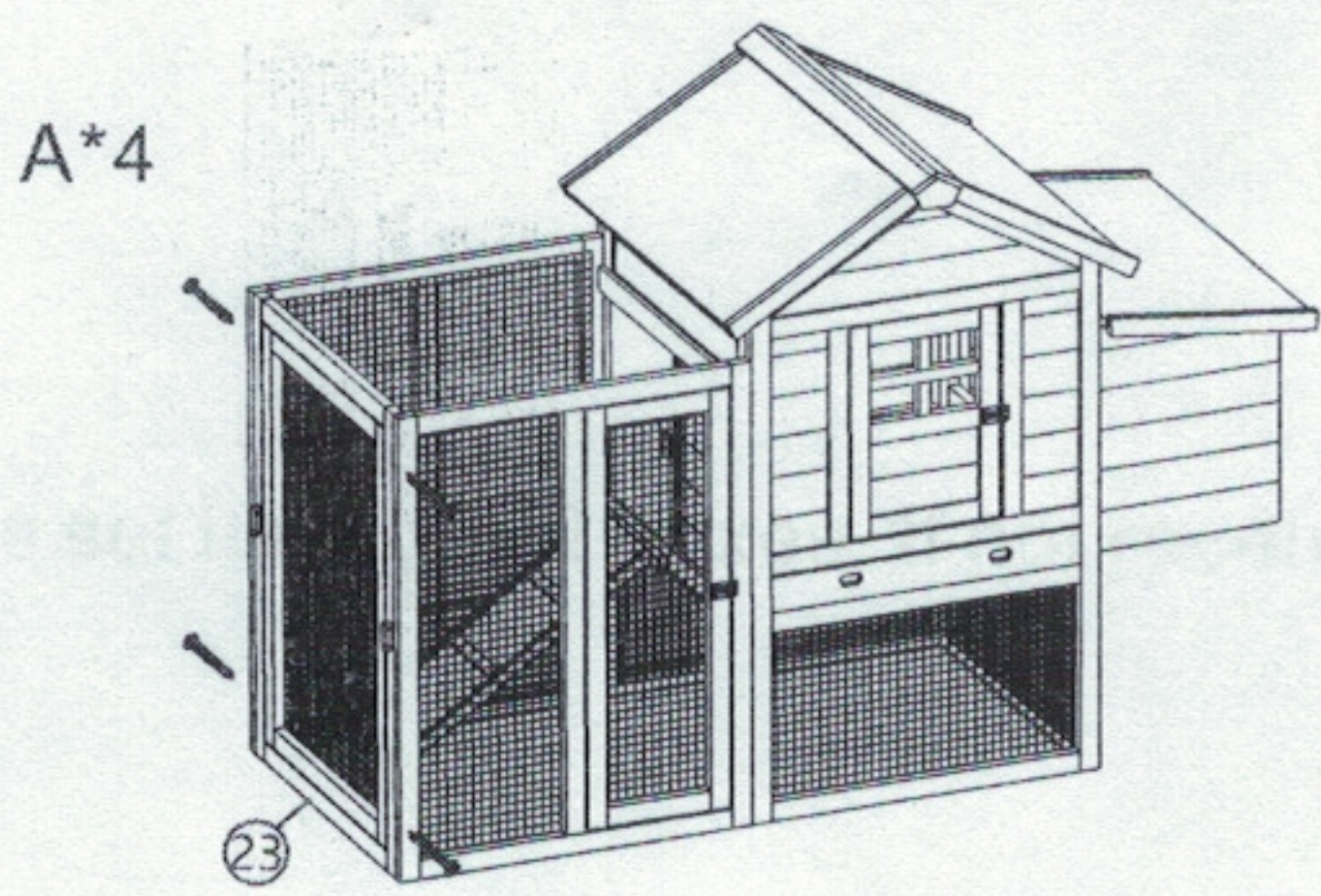

Step 27

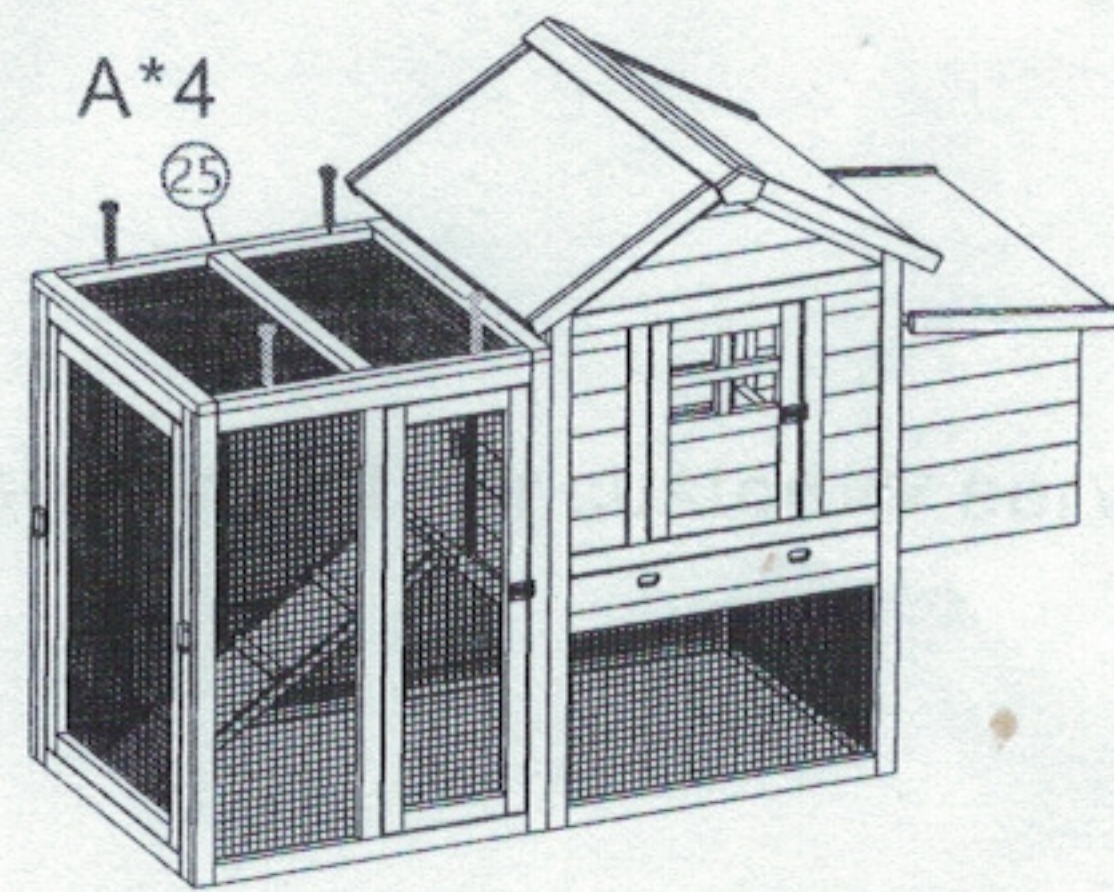

Step 28

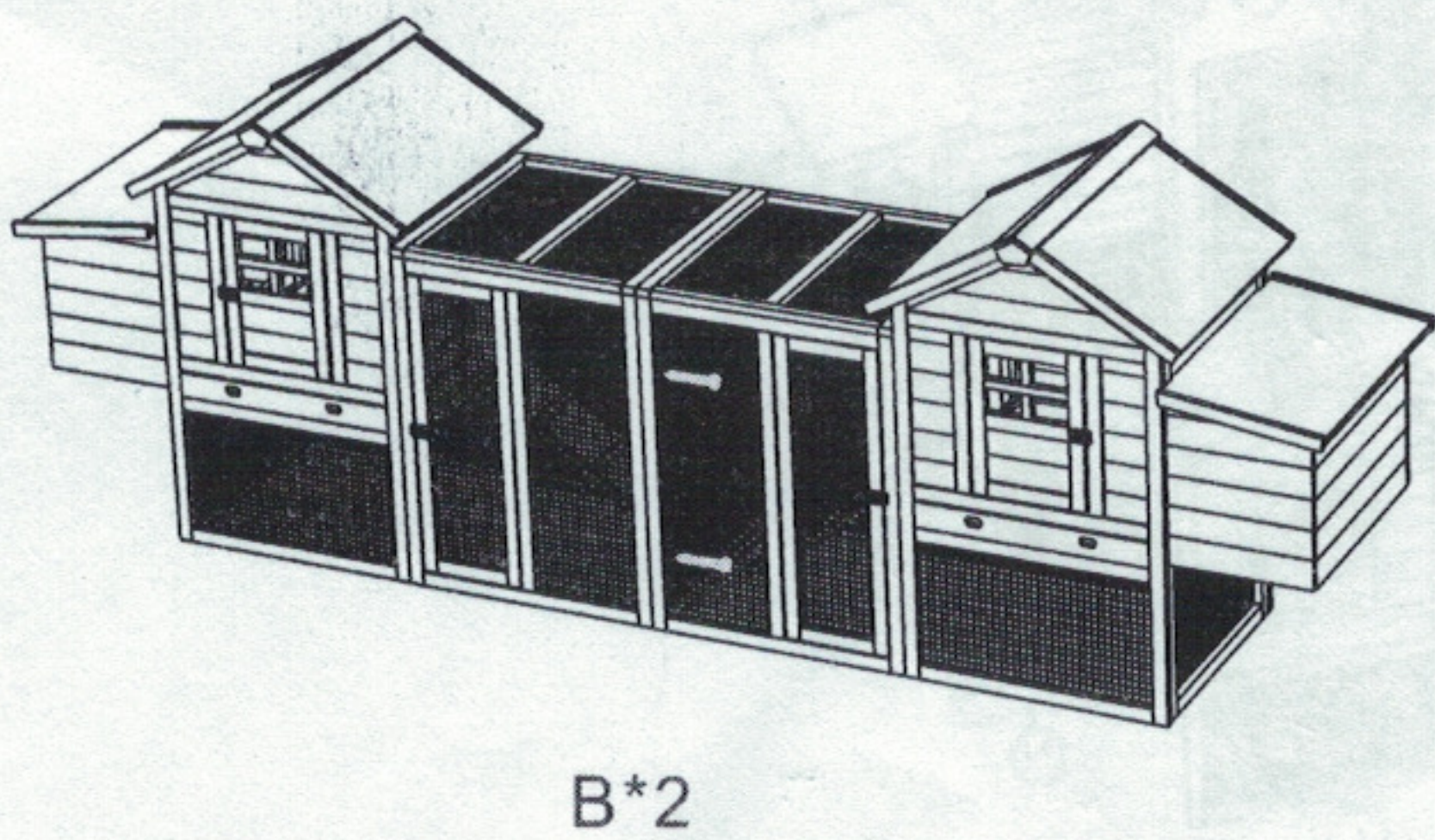

Step 29

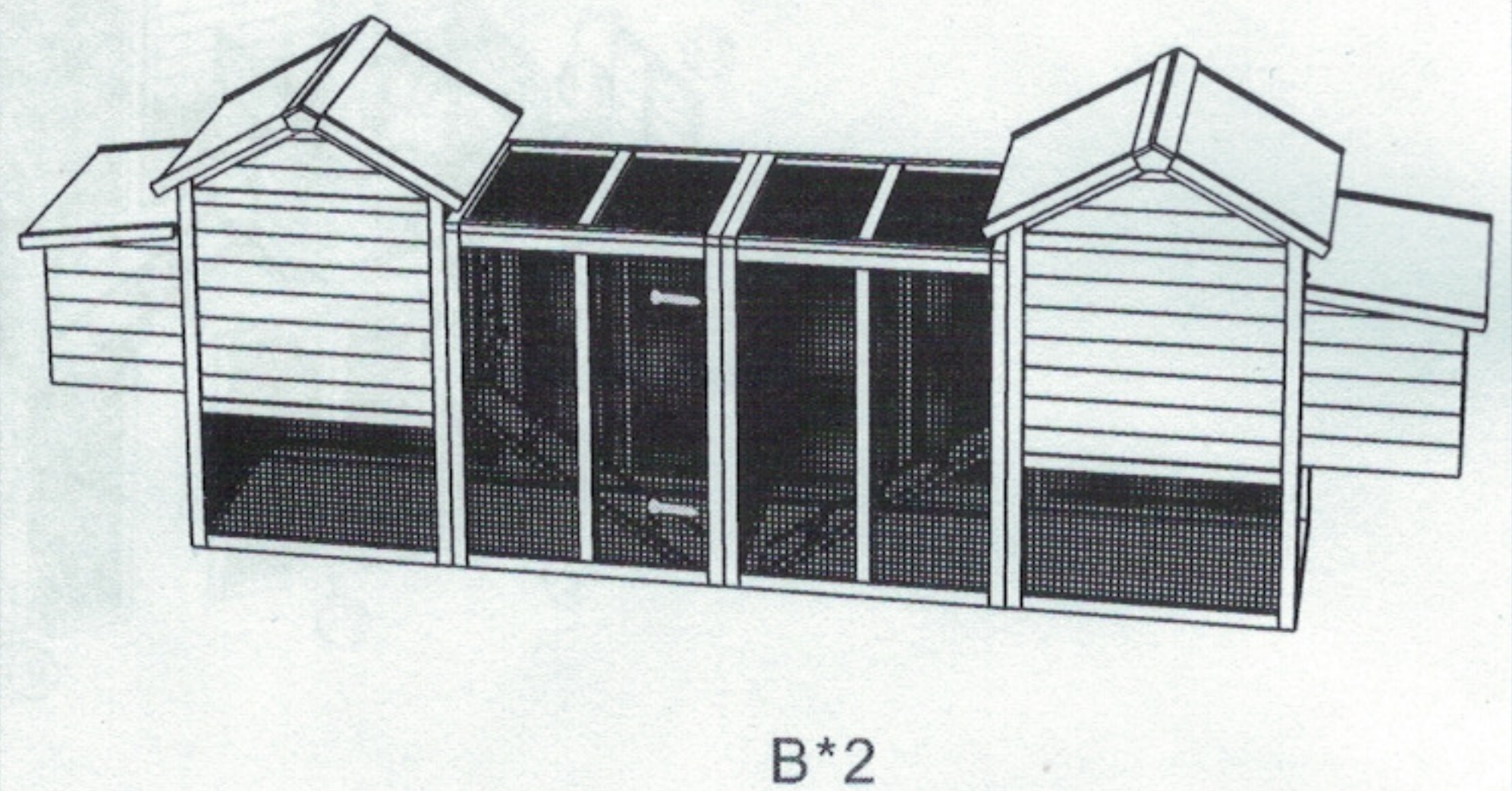

Step 30