

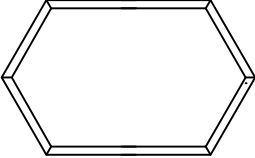









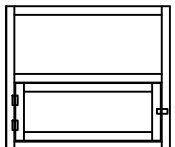
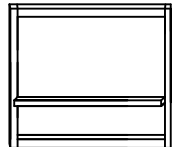

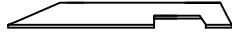









| | | | | |
|--|--|--|--|--|
| A*1  | | B*1  | | |
| C*1  | | D*1  | | |
| E*2  | F*2  | G*1  | | |
| | | S*1  | T*1  | V*1  |
| H*1  | I*1  | J*2  | K*1  | L*2  |
| M*2  | N*2  | O*4  | P*1  | Q*1  |
| R1  | R2  | R3  | R4  | R5  |
| 3.5*35 =10PCS | 3.5*25 =12PCS | 3*20 =13PCS | 3*16 =24PCS | 3*10 =2PCS |





R3 3*20=8PCS
 R1 3.5*35=4PCS

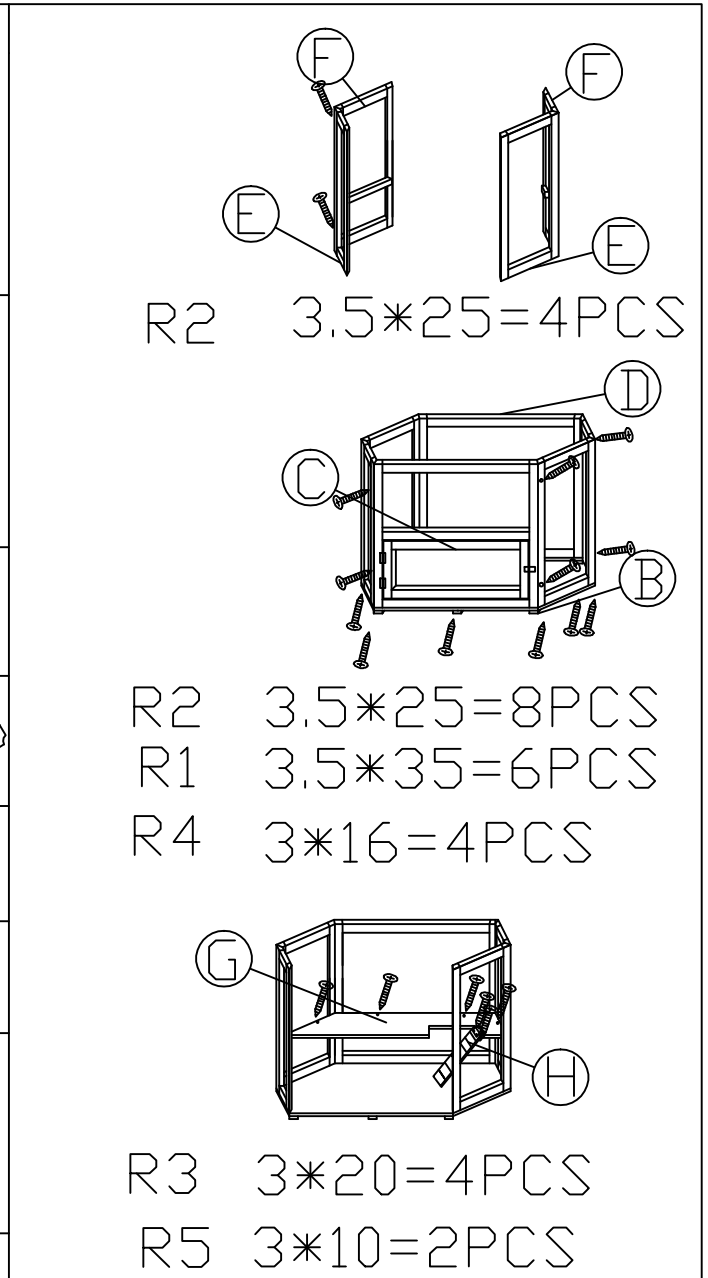
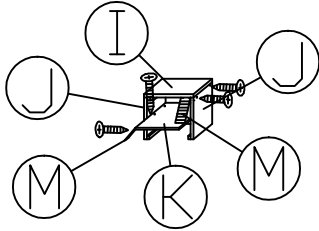
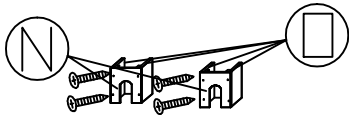
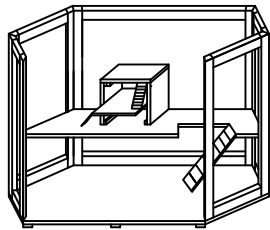

R4 3*16=8PCS

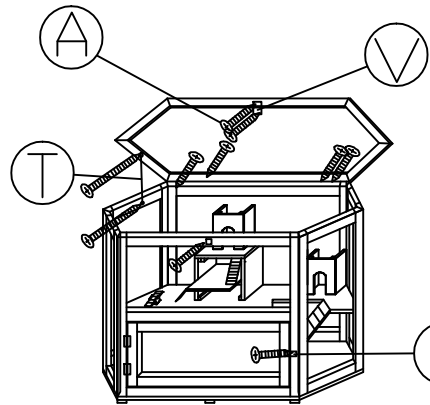
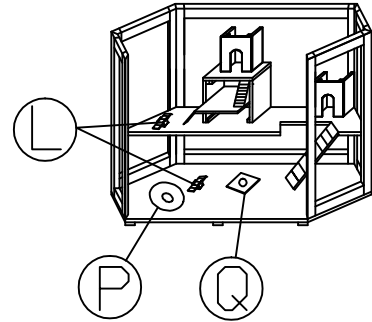
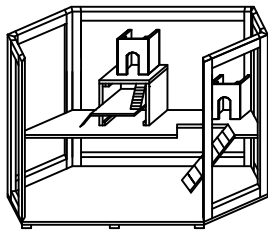

R4 3*16=12PCS
 R3 3*20=1PCS