

inthemarket.ie

home • garden • leisure

# HEN RUN MANUAL

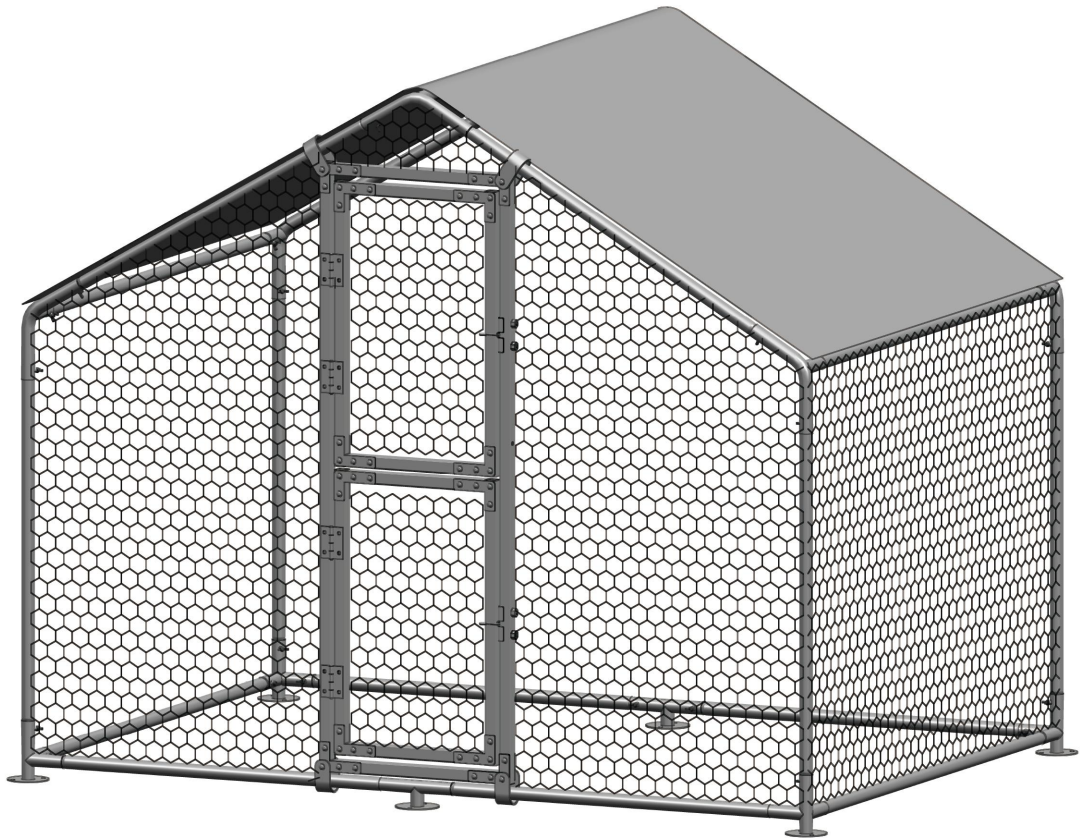







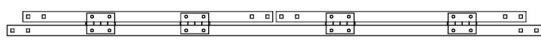

**3mx2mx2m**



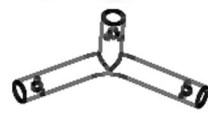





Please read this manual carefully before assembly

# 3m x 2m x 2m Part List

Part No.	Part Size	Part Picture	Part Quantity
①	1400mm		4
②	1870mm		5
③	970mm		4
④	1505mm		4
⑤	1740mm		1
⑥	1740mm		1
⑦	815mm		2
⑧	570mm		2
⑨	490mm		4
A			2
C			4
D			6
F			1
G			4
H			12
I	roof cover		1

# ○ 3m x 2m x 2m

Part No.	Part Size	Part Picture	Part Quantity
J			44
K			24
L			2
M			2
	steel wire		1
	cable tie		200

# 3m x 2m x 2m

## Step 1 - Building the Base

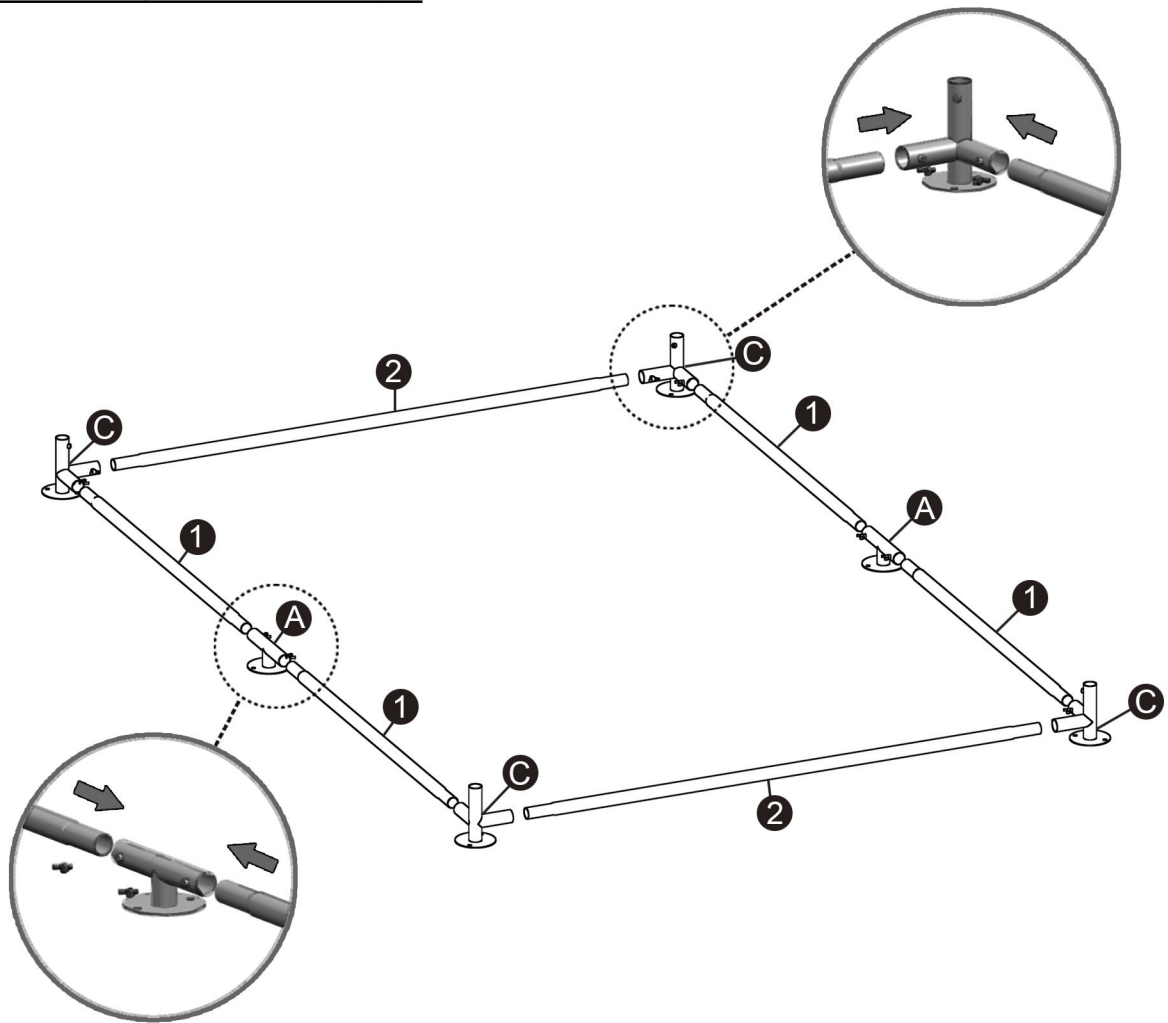

## Step 2 - Assembling the Columns

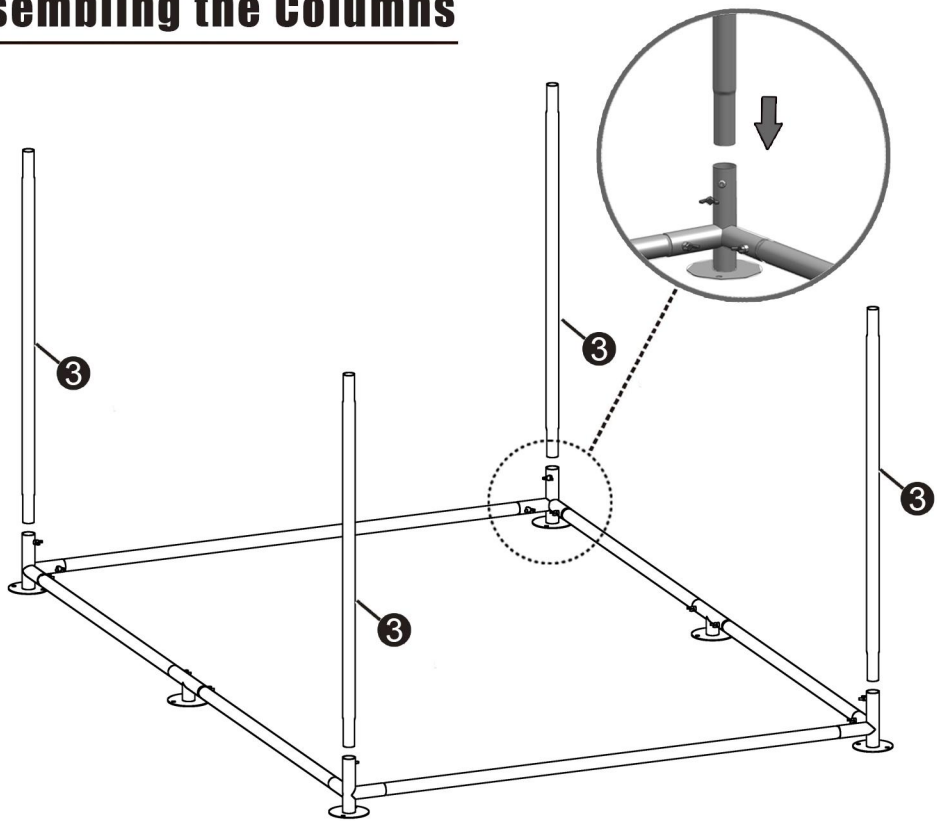

# 3m x 2m x 2m

## Step 3 - Building the Top Frame

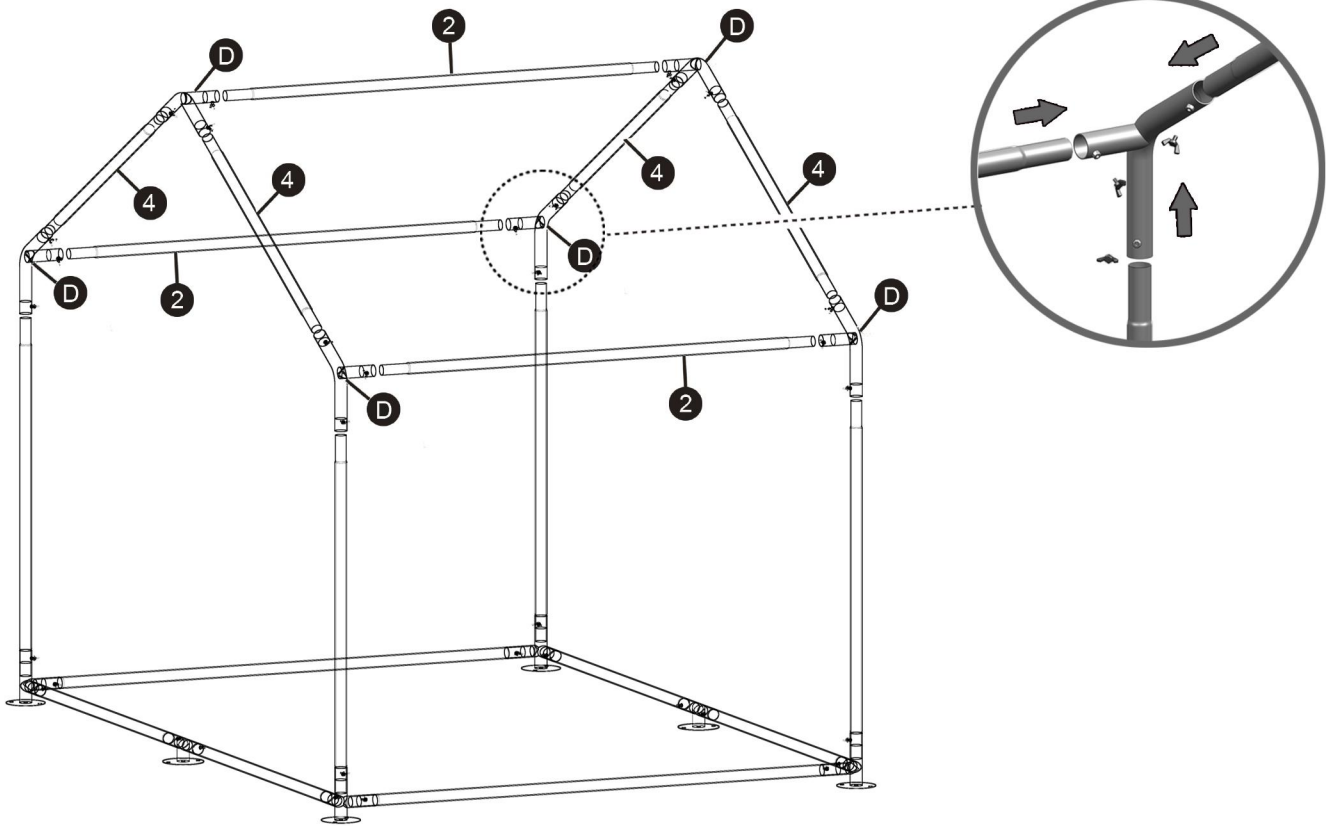

## Step 4 - Preparing the Door

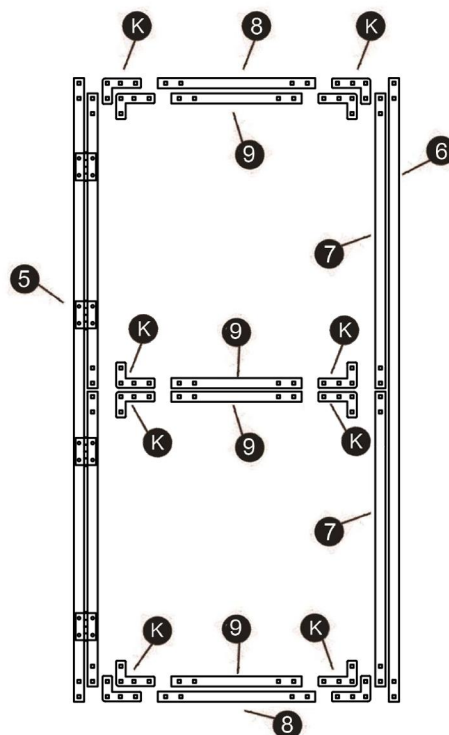

# 3m x 2m x 2m

---

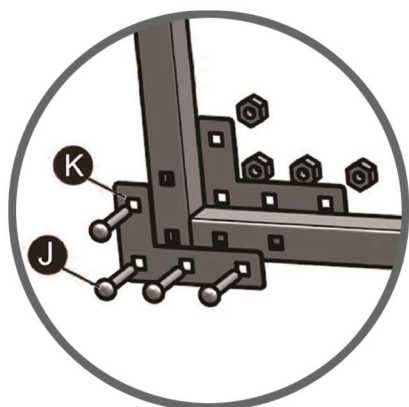
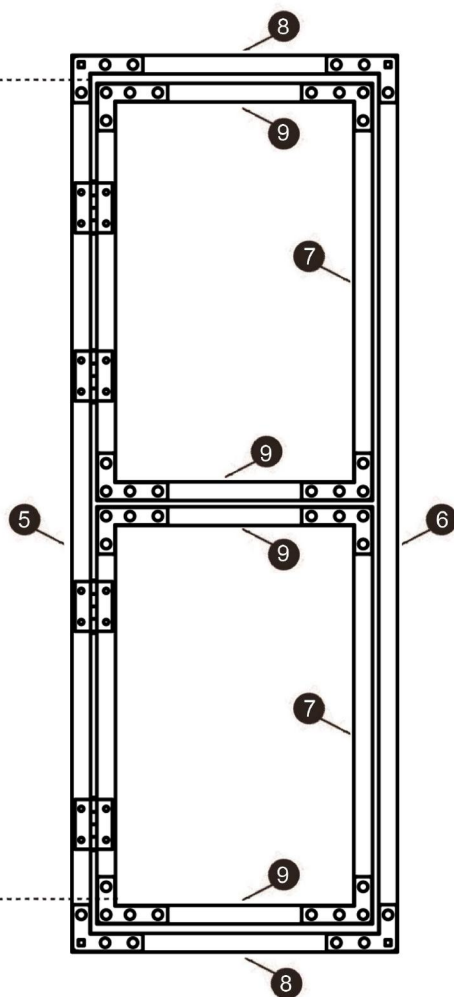
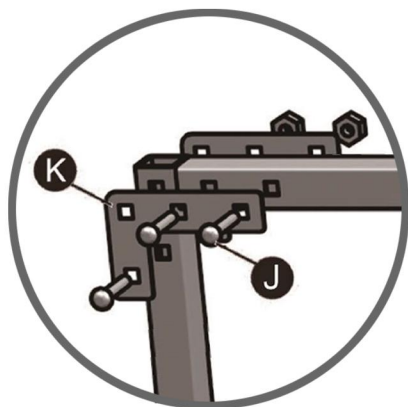

# 3m x 2m x 2m

## Step 5 - Assembling the Door

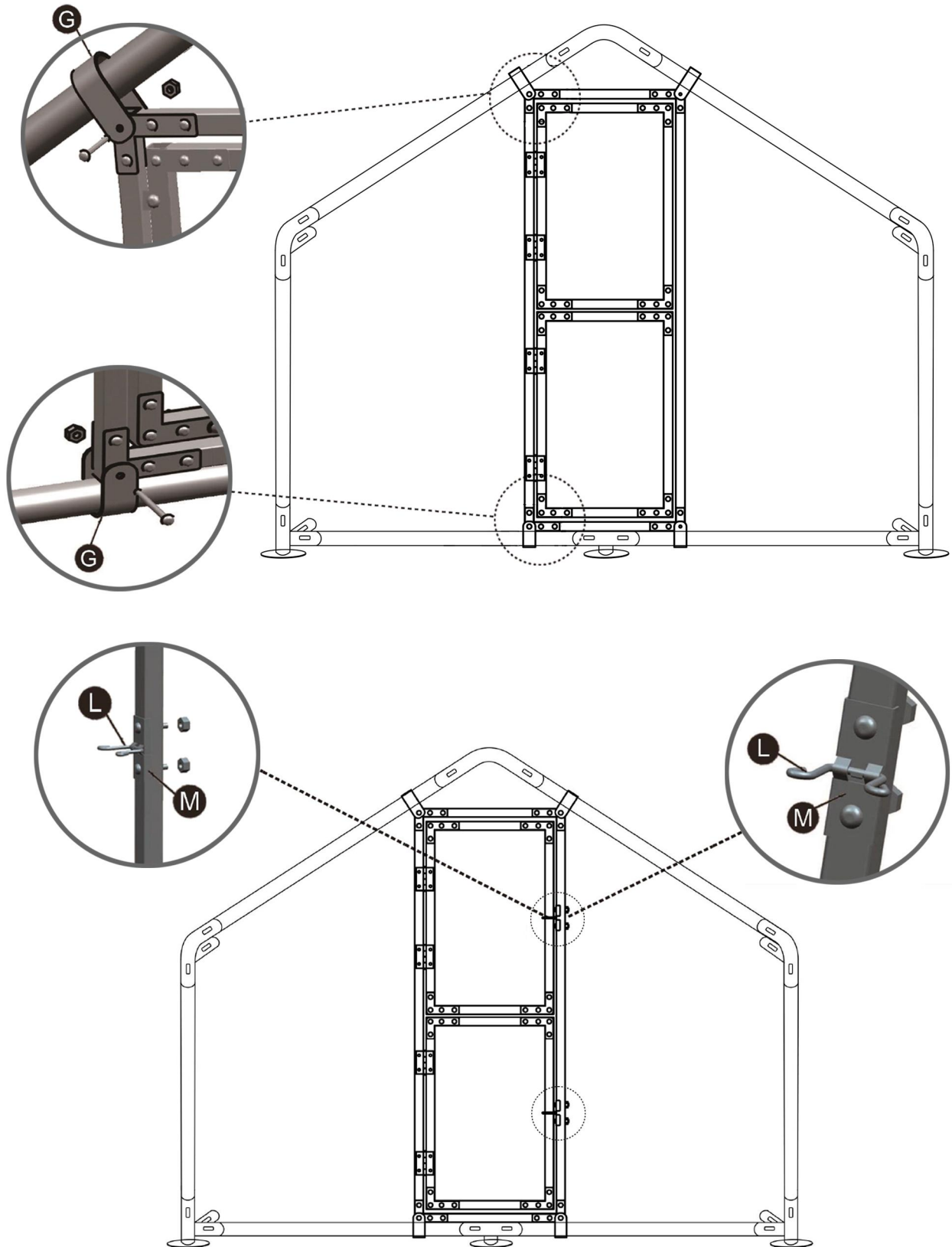

## ○ 3m x 2m x 2m

### Step 6 - Fixing the Roof Cover and Mesh

The chicken wire is provided in 1m width rolls. With this in mind, we advise completing the wire fix by connecting it to one of the side ground bars. Then feed the wire over the top, centre pole to connect to the adjacent ground bar. Once this process has been done, twice for each bay, you should connect the two runs of wire to each other using the cable ties supplied. Using the remaining wire, we recommend running the wire horizontally for both the front and back sections of the run. You should cut the wire as you go along to match the shape of the area. Once you are happy with the the wire install, you can attach the roof by sitting the cover over the top of the roof section and connect using the elasticated ball ties supplied.

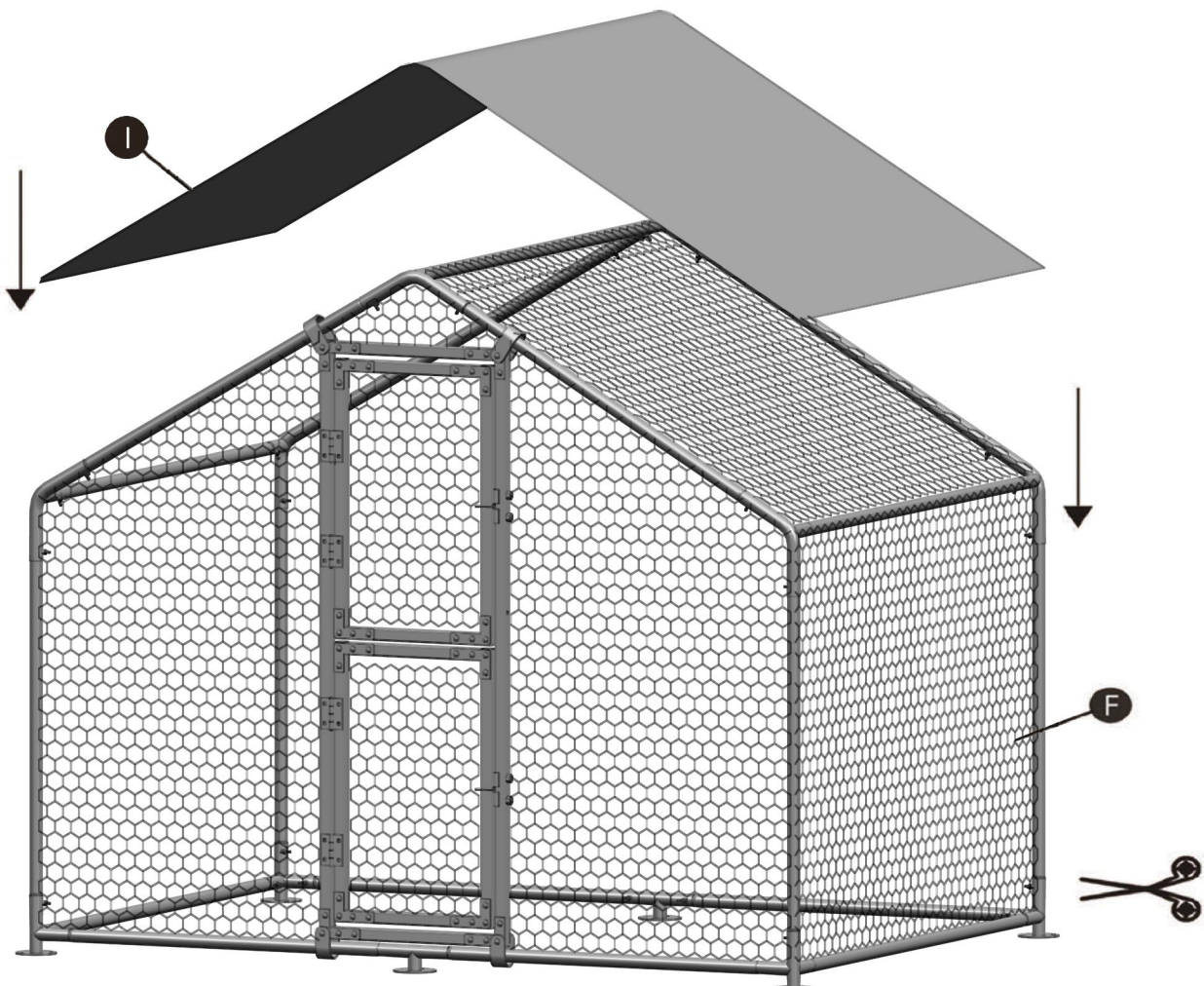



## ○ 3m x 2m x 2m

---

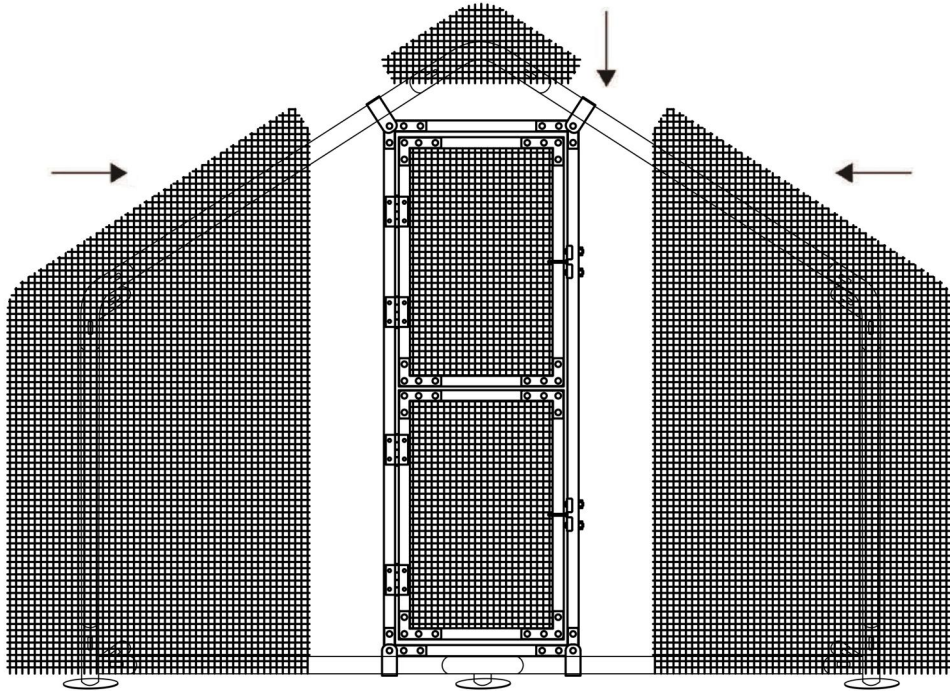

### **Step 7 - Fixing the Structure**

**Use supplied pegs to push through the feet holes as shown in the diagram. We recommend using all of the pegs to prevent movement of the structure.**

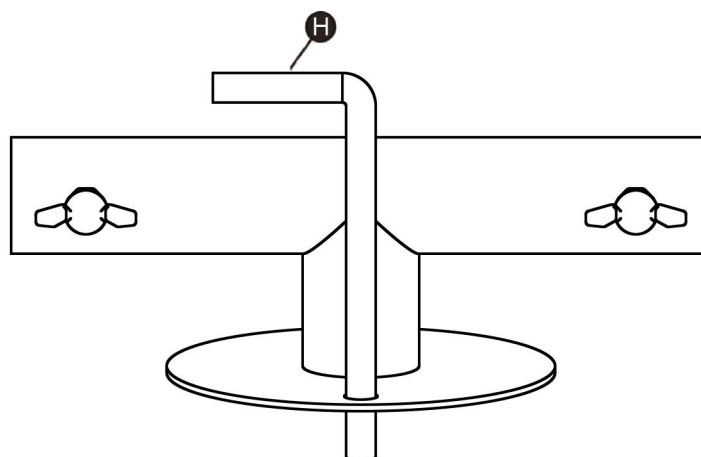

 **3m x 2m x 2m**

---

**Thank You for Buying from InTheMarket.ie!**

**We appreciate your support. As a valued customer, please use the discount code ITM5 for your next purchase for a 5% discount. Feel free to share with family and friends. We hope that you have many happy years with your new Hen Run. Please note that even outside of your warranty, we carry spares and we also have a repair service available, so your product will last for many, many years.**

**We Would Love to Hear What You Think.**

**We are a small, Irish, family business and we only sell to the Irish people. We Irish love to hear about other people's experiences, so it would mean a lot if you could take a few minutes to leave a review about our products and service on [www.TrustPilot.com](http://www.TrustPilot.com). Just search for [Inthemarket.ie](http://Inthemarket.ie). Thanks again.**

**Follow Us for Discounts, Offers and New Products**



**@inthemarket.ie**



**@marketinthe**



**@inthemarket99**

**Registered Company: Bunanstua Ltd., t/a InTheMarket.ie**

**Tel:021-4389345 Email: [info@inthemarket.ie](mailto:info@inthemarket.ie)**

**VAT Registered 3700247RH. CRO Number 672650.**

**Copyright © 2022. All rights reserved by InTheMarket.ie**